

"C" Series Plugs - 1 = 1/16"

"C" Series - Straight Through Male Plugs

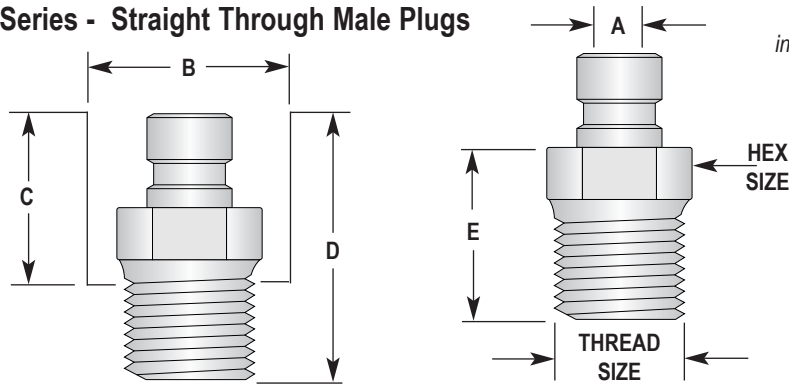

High quality brass connector
interchangeable with Parker Moldmate
DME, OBAC Mold Tite, etc.

USE WITH BODY SIZE	NOMINAL BODY SIZE	THREAD SIZE	HEX SIZE	"A"	"B"	"C" F	"D"	"E"	PART NO.	PRICE
.704"	1/4"	1/8" - 27	7/16"	.240	.844	.70	.94	.52	CMP-04-02	... \$.85
.704"	1/4"	1/4" - 18	9/16"	.240	.844	.85	1.13	.70	CMP-04-04	... \$.86
.950"	3/8"	1/4" - 18	9/16"	.364	1.00	1.00	1.34	.70	CMP-06-04	... \$.99
.950"	3/8"	3/8" - 18	11/16"	.364	1.00	1.14	1.38	.73	CMP-06-06	... \$ 1.82
1.200"	1/2"	1/2" - 14	7/8"	.592	1.25	1.50	1.69	.90	CMP-08-08	... \$ 2.75

"C" Series - Straight Through Plated Steel Female Plugs

SIZE

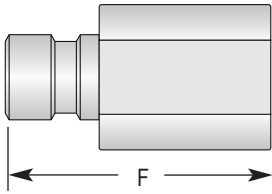

BODY SIZE	THREAD SIZE	HEX "F"	PART NO.	PRICE
1/4"	1/8" - 27	7/16"	.97 CFP-04-02	... \$ 1.06
1/4"	1/4" - 18	9/16"	1.28 CFP-04-04	... \$ 1.22
3/8"	1/4" - 18	9/16"	1.47 CFP-06-04	... \$ 1.17
3/8"	3/8" - 18	3/4"	1.59 CFP-06-06	... \$ 1.97
1/2"	1/2" - 14	15/16"	1.77 CFP-08-08	... \$ 3.56

"C" Series - Straight Through Male Extension Plugs

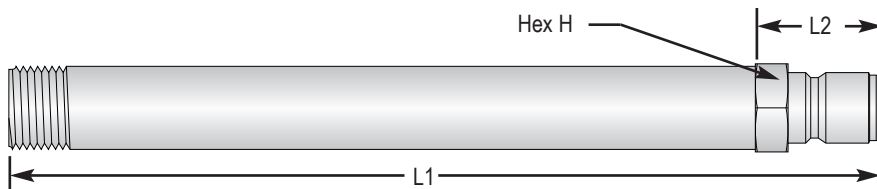

BODY SIZE	NPT LENGTH	(L1)	LENGTH(L2)	HEX(H)	PART NO.	PRICE
1/4"	1/8" - 27	2"	11/16"	7/16"	MEP-04-02-2	... \$ 2.56
1/4"	1/8" - 27	4"	11/16"	7/16"	MEP-04-02-4	... \$ 3.10
1/4"	1/8" - 27	6"	11/16"	7/16"	MEP-04-02-6	... \$ 6.62
1/4"	1/8" - 27	8"	11/16"	7/16"	MEP-04-02-8	... \$ 6.62
1/4"	1/4" - 18	2"	11/16"	7/16"	MEP-04-04-2	... \$ 2.84
1/4"	1/4" - 18	4"	11/16"	7/16"	MEP-04-04-4	... \$ 2.84
1/4"	1/4" - 18	6"	11/16"	7/16"	MEP-04-04-6	... \$ 7.60
1/4"	1/4" - 18	8"	11/16"	7/16"	MEP-04-04-8	... \$ 8.75
3/8"	1/8" - 18	2"	11/16"	7/16"	MEP-06-02-2	... \$ 2.83
3/8"	1/8" - 18	6"	11/16"	7/16"	MEP-06-02-6	... \$ 7.13
3/8"	1/4" - 18	2"	1-1/32"	9/16"	MEP-06-04-2	... \$ 2.84
3/8"	1/4" - 18	4"	1-1/32"	9/16"	MEP-06-04-4	... \$ 3.42
3/8"	1/4" - 18	6"	1-1/32"	9/16"	MEP-06-04-6	... \$ 7.27
3/8"	1/4" - 18	8"	1-1/32"	9/16"	MEP-06-04-8	... \$ 9.79

AVAILABLE UP TO 17 INCHES LONG - QUOTATION UPON REQUEST

CITO-FP-PRICE-22-0812

"C" Series Quick Connector Couplings - 1 = 1/16"

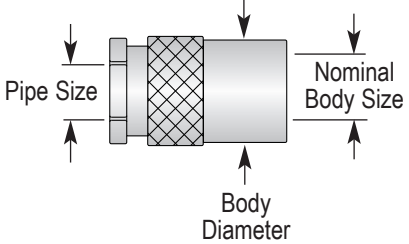
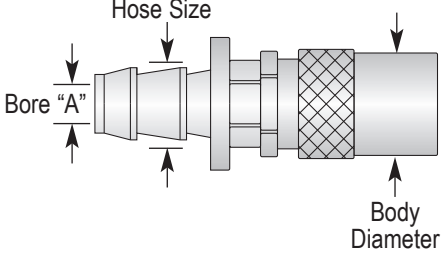
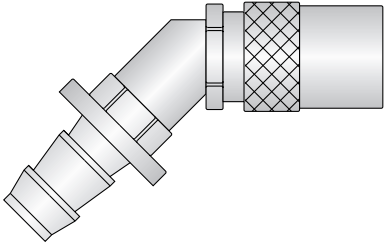
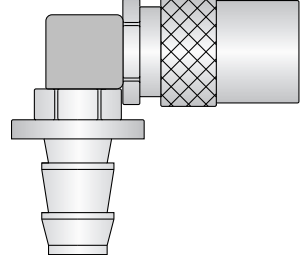
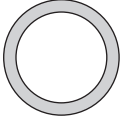
Socket "C" Series						
NOMINAL BODY SIZE	BODY DIAMETER	PIPE SIZE	PART NO.	PRICE		
1/4"	.704	1/8"	CS-04-02	\$ 4.37		
1/4"	.704	1/4"	CS-04-04	\$ 5.35		
3/8"	.950	1/4"	CS-06-04	\$ 5.38		
3/8"	.950	3/8"	CS-06-06	\$ 6.10		
1/2"	1.200	1/2"	CS-08-08	\$ 9.56		
Hose Socket "C" Series						
NOMINAL BODY SIZE	BODY DIAMETER	HOSE SIZE	BORE "A"	PART NO.	PRICE	
1/4"	.704	1/4"	.238	CHS-04-04	\$ 5.54	
1/4"	.704	3/8"	.300	CHS-04-06	\$ 5.72	
3/8"	.950	3/8"	.300	CHS-06-06	\$ 6.84	
3/8"	.950	1/2"	.408	CHS-06-08	\$ 7.27	
1/2"	1.200	1/2"	.408	CHS-08-08	\$12.87	
Hose Socket "C" Series 45°						
NOMINAL BODY SIZE	BODY DIAMETER	HOSE SIZE	BORE "A"	PART NO.	PRICE	
1/4"	.704	1/4"	.238	CHS-45-04-04	\$ 7.13	
1/4"	.704	3/8"	.300	CHS-45-04-06	\$ 7.13	
3/8"	.950	3/8"	.300	CHS-45-06-06	\$ 8.78	
3/8"	.950	1/2"	.408	CHS-45-06-08	\$ 9.23	
Hose Socket "C" Series 90°						
NOMINAL BODY SIZE	BODY DIAMETER	HOSE SIZE	BORE "A"	PART NO.	PRICE	
1/4"	.704	1/4"	.238	CHS-90-04-04	\$ 7.16	
1/4"	.704	3/8"	.300	CHS-90-04-06	\$ 7.34	
3/8"	.950	3/8"	.300	CHS-90-06-06	\$ 8.57	
3/8"	.950	1/2"	.408	CHS-90-06-08	\$ 9.02	
1/2"	1.200	1/2"	.408	CHS-90-08-08	\$17.69	
"C" Series Seals						
NOMINAL BODY SIZE			PART NO.	PRICE		
1/4"			CVS-04	\$ 2.70/10		
3/8"			CVS-06	\$ 3.78/10		
1/2"			CVS-08	\$ 10.80/10		

CITO-FP-PRICE-22-0812

"S" Series Hose Couplings - 1 = 1/16"

Male Plug

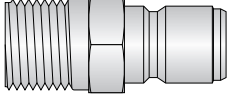

SIZE	PART NO.	PRICE
1/4"	MP-04	\$ 1.94
3/8"	MP-06	\$ 2.27
1/2"	MP-08	\$ 4.09
3/4"	MP-12	\$ 7.29
1"	MP-16	\$ 18.76
1-1/4"	MP-20	\$ 31.02
1-1/2"	MP-24	\$ 44.02
2"	MP-32	\$ 68.22

Male Socket

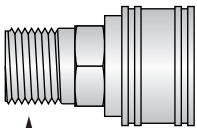

NPT

SIZE	PART NO.	PRICE
1/4"	MS-04	\$ 5.42
3/8"	MS-06	\$ 6.70
1/2"	MS-08	\$ 9.63
3/4"	MS-12	\$ 14.39
1"	MS-16	\$ 20.71

Female Plug

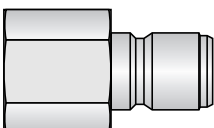

SIZE	PART NO.	PRICE
1/4"	FP-04	\$ 1.94
3/8"	FP-06	\$ 2.27
1/2"	FP-08	\$ 4.09
3/4"	FP-12	\$ 7.29
1"	FP-16	\$ 15.53
1-1/4"	FP-20	\$ 27.08
1-1/2"	FP-24	\$ 53.73
2"	FP-32	\$ 59.79

Female Socket

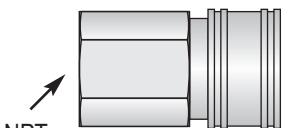

NPT

SIZE	PART NO.	PRICE
1/4"	FS-04	\$ 5.42
3/8"	FS-06	\$ 6.70
1/2"	FS-08	\$ 9.63
3/4"	FS-12	\$ 17.18
1"	FS-16	\$ 26.21
1-1/4"	FS-20	\$ 55.90
1-1/2"	FS-24	\$ 94.43
2"	FS-32	\$ 127.44

Hose Plug

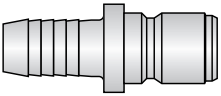

SIZE	PART NO.	PRICE
1/4"	*HP-04	\$ 3.33
3/8"	*HP-06	\$ 4.09
1/2"	*HP-08	\$ 7.79
3/4"	*HP-12	\$ 10.19
1"	*HP-16	\$ 17.26

*Use with Hose Clamps

Hose Socket

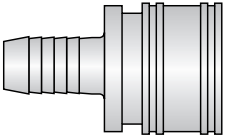

SIZE	PART NO.	PRICE
1/4"	*HS-04	\$ 8.06
3/8"	*HS-06	\$ 8.89
1/2"	*HS-08	\$ 14.44
3/4"	*HS-12	\$ 17.26

*Use with Hose Clamps

CITO-FP-PRICE-22-0812

Hose Fittings - 1 = 1/16"

Push-Loc Hose to Male Pipe Fitting (No Clamps Required)

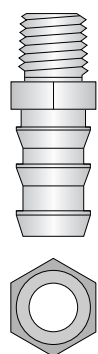

Pipe Thread (in NPT)

Hose Barb
(to fit inside diameter of hose)

Flow Area (Sq. In.)

THREAD SIZE	HOSE (INSIDE DIAMETER)	HOLE DIAMETER
1/8"	1/4"	.190"
1/8"	*3/8"	.275"
1/4"	1/4"	.190"
1/4"	*3/8"	.285"
1/4"	*1/2"	.346"
3/8"	1/4"	.190"
3/8"	3/8"	.285"
3/8"	*1/2"	.410"
1/2"	1/2"	.410"
1/2"	*3/4"	.564"
3/4"	3/4"	.660"
1"	1"	.813"

PART NO.	PRICE
PLMP-04-02	\$1.13
*PLMP-06-02	\$1.93
PLMP-04-04	\$1.35
*PLMP-06-04	\$1.49
*PLMP-08-04	\$2.21
PLMP-04-06	\$1.78
PLMP-06-06	\$1.73
*PLMP-08-06	\$1.93
PLMP-08-08	\$3.24
*PLMP-12-08	\$4.45
PLMP-12-12	\$4.64
PLMP-16-16	\$12.42

* PL MP - 06 - 04

Thread -02=1/8" - 04=1/4" - 06=3/8" - 08=1/2" - 12=3/4" - 16 = 1"
 Hose - 04=1/4" - 06=3/8" - 08=1/2" - 12 = 3/4" - 16 = 1"
 MP=Male Pipe
 FP=Female Pipe
 Push-Loc (No hose clamp required)
 High Flow (preferred size)

*Indicates preferred sizes for best flow rate

Push-Loc Hose to Female Pipe

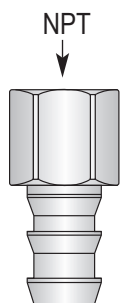

THREAD SIZE	HOSE (INSIDE DIAMETER)	HOLE DIAMETER
1/8"	1/4"	.19"
1/8"	3/8"	.28"
1/4"	1/4"	.19"
1/4"	3/8"	.28"
1/4"	1/2"	.41"
3/8"	3/8"	.28"
3/8"	1/2"	.41"
1/2"	1/2"	.41"
3/4"	3/4"	.67"

PART NO.	PRICE
PLFP-04-02	\$ 1.78
*PLFP-06-02	\$ 2.93
PLFP-04-04	\$ 1.82
*PLFP-06-04	\$ 1.85
*PLFP-08-04	\$ 2.72
PLFP-06-06	\$ 2.32
*PLFP-08-06	\$ 2.59
PLFP-08-08	\$ 3.17
PLFP-12-12	\$ 6.25

*Indicates preferred sizes for best flow rate

Barbed Male Fittings - Use with Hose Clamp

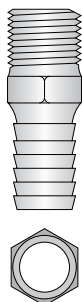

NPT

THREAD SIZE	HOSE (INSIDE DIAMETER)	HOLE DIAMETER
3/4"	1"	.750"
1"	1"	.875"
1"	1-1/4"	.940"
1-1/4"	1-1/4"	.980"
1-1/4"	1-1/2"	1.280"
1-1/2"	1-1/2"	1.214"
1-1/2"	2"	1.728"
2"	2"	1.824"

PART NO.	PRICE
*HCMB-16-12	\$ 3.31
HCMB-16-16	\$ 7.00
*HCMB-20-16	\$ 27.20
HCMB-20-20	\$ 24.01
HCMB-24-20	\$ 34.94
HCMB-24-24	\$ 32.48
HCMB-32-24	\$ 64.60
HCMB-32-32	\$ 38.82

*Indicates preferred sizes for best flow rate

Due to fluctuating brass prices, please check for current prices.

CITO-FP-PRICE-22-0812

Valves, Bushings, Plugs and Coupling - 1 = 1/16"

Full Flow Brass Ball Valves Female/Female

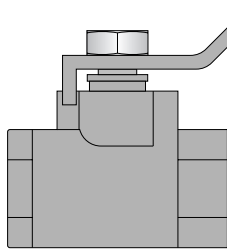

600 lbs.
water/gas/oil
(600WOG)

SIZE	PART NO.	PRICE
1/4"	BVFF-04	\$ 10.73
3/8"	BVFF-06	\$ 10.21
1/2"	BVFF-08	\$ 11.36
3/4"	BVFF-12	\$ 16.78
1"	BVFF-16	\$ 20.73
1-1/4"	BVFF-20	\$ 36.71
1-1/2"	BVFF-24	\$ 69.02
2"	BVFF-32	\$ 61.78

Full Flow Brass Ball Valves Male/Female

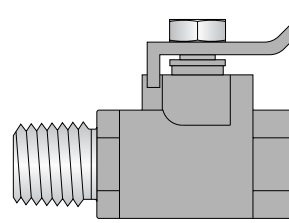

600 lbs.
water/gas/oil
(600WOG)

SIZE	PART NO.	PRICE
1/8"	BVMF-02	\$ 14.78
1/4"	BVMF-04	\$ 16.30
3/8"	BVMF-06	\$ 15.60
1/2"	BVMF-08	\$ 14.87
3/4"	BVMF-12	\$ 23.76
1"	BVMF-16	\$ 34.22

Female Couplings

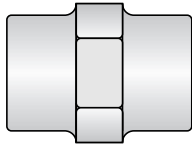

SIZE	PART NO.	PRICE
1/8"	FC-02	\$ 3.20
1/4"	FC-04	\$ 2.45
3/8"	FC-06	\$ 3.02
1/2"	FC-08	\$ 4.39
3/4"	FC-12	\$ 5.27
1"	FC-16	\$ 8.01
1-1/4"	FC-20	\$ 12.51
1-1/2"	FC-24	\$ 17.01
2"	FC-32	\$ 21.78

Reducer Couplings

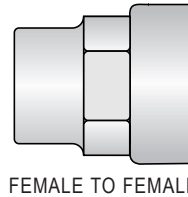

FEMALE TO FEMALE

SIZE	PART NO.	PRICE
1"x1/2"	RC-16-08	\$ 9.04
1"x3/4"	RC-16-12	\$ 9.04
1-1/4"x1"	RC-20-16	\$ 14.58
1-1/2"x1"	RC-24-16	\$ 14.34
1-1/2"x1-1/4"	RC-24-20	\$ 14.34
2"x1"	RC-32-16	\$ 24.00
2"x1-1/4"	RC-32-20	\$ 21.29
2"x1-1/2"	RC-32-24	\$ 21.29

Reducer Bushings Brass Male/Female

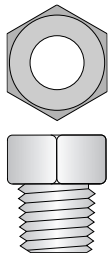

SIZE	PART NO.	PRICE
1/4" x 1/8"	RB-04-02	\$ 1.08
3/8" x 1/8"	RB-06-02	\$ 1.71
3/8" x 1/4"	RB-06-04	\$ 1.53
1/2" x 1/8"	RB-08-02	\$ 2.65
1/2" x 1/4"	RB-08-04	\$ 2.25
1/2" x 3/8"	RB-08-06	\$ 4.16
3/4" x 1/8"	RB-12-02	\$ 4.16
3/4" x 1/4"	RB-12-04	\$ 4.46
3/4" x 3/8"	RB-12-06	\$ 3.78
3/4" x 1/2"	RB-12-08	\$ 3.74
1" x 1/2"	RB-16-08	\$ 5.27
1" x 3/4"	RB-16-12	\$ 6.05
1-1/4" x 3/4"	RB-20-12	\$ 8.98
1-1/4" x 1"	RB-20-16	\$ 8.98
1-1/2" x 3/4"	RB-24-12	\$ 14.04
1-1/2" x 1"	RB-24-16	\$ 11.48
1-1/2" x 1-1/4"	RB-24-20	\$ 11.48

Brass Plugs

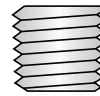

SIZE	PART NO.	PRICE
1/16" HEX	BP-01	\$.32
1/8" HEX	BP-02	\$.29
1/4" HEX	BP-04	\$.38
3/8" HEX	BP-06	\$.63
1/2" HEX	BP-08	\$ 1.03
3/4" SQ	BP-12	\$ 1.82
1" SQ	BP-16	\$ 3.80
1-1/4" SQ	BP-20	\$ 7.22
1-1/2" SQ	BP-24	\$ 9.49
2" SQ	BP-32	\$ 13.32

CITO-FP-PRICE-22-0812

Brass Elbows and Brass Nipples - 1 = 1/16"

Brass 90° Elbow

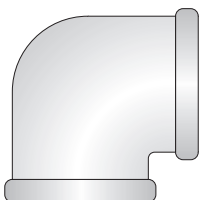

SIZE	PART NO.	PRICE
1/8"	EL-90-02	\$ 2.32
1/4"	EL-90-04	\$ 3.33
3/8"	EL-90-06	\$ 5.26
1/2"	EL-90-08	\$ 6.89
3/4"	EL-90-12	\$ 6.44
1"	EL-90-16	\$ 10.06
1-1/4"	EL-90-20	\$ 15.98
1-1/2"	EL-90-24	\$ 16.80
2"	EL-90-32	\$ 25.27

Brass 90° Street Elbow

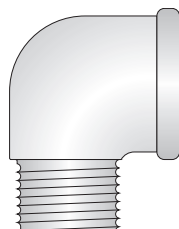

SIZE	PART NO.	PRICE
1/8"	SE-90-02	\$ 1.24
1/4"	SE-90-04	\$ 3.92
3/8"	SE-90-06	\$ 3.80
1/2"	SE-90-08	\$ 6.35
3/4"	SE-90-12	\$ 10.33
1"	SE-90-16	\$ 13.77
1-1/4"	SE-90-20	\$ 20.34
1-1/2"	SE-90-24	\$ 21.34
2"	SE-90-32	\$ 36.93

Brass Street 45° Elbow

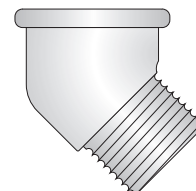

SIZE	PART NO.	PRICE
1/8"	SE-45-02	\$ 1.64
1/4"	SE-45-04	\$ 2.74
3/8"	SE-45-06	\$ 4.07
1/2"	SE-45-08	\$ 6.73
3/4"	SE-45-12	\$ 7.27
1"	SE-45-16	\$ 12.04
1-1/4"	SE-45-20	\$ 14.34
1-1/2"	SE-45-24	\$ 19.25
2"	SE-45-32	\$ 32.62

Brass 45° Elbow

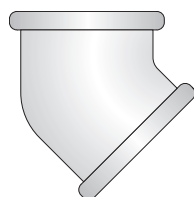

SIZE	PART NO.	PRICE
1/8"	EL-45-02	\$ 4.10
1/4"	EL-45-04	\$ 3.42
3/8"	EL-45-06	\$ 3.44
1/2"	EL-45-08	\$ 4.34
3/4"	EL-45-12	\$ 6.41
1"	EL-45-16	\$ 10.80
1-1/4"	EL-45-20	\$ 17.24
1-1/2"	EL-45-24	\$ 16.80
2"	EL-45-32	\$ 27.80

Brass Street Tee

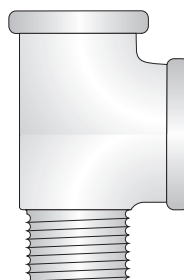

SIZE	PART NO.	PRICE
1/8"	ST-02	\$ 2.63
1/4"	ST-04	\$ 4.86
3/8"	ST-06	\$ 5.80
1/2"	ST-08	\$ 11.29
3/4"	ST-12	\$ 18.59
1"	ST-16	\$ 43.20
1-1/4"	ST-20	\$ 48.48

Brass Tee

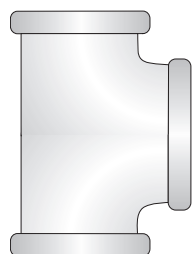

SIZE	PART NO.	PRICE
1/8"	BT-02	\$ 4.43
1/4"	BT-04	\$ 4.43
3/8"	BT-06	\$ 4.43
1/2"	BT-08	\$ 5.56
3/4"	BT-12	\$ 8.01
1"	BT-16	\$ 14.24
1-1/4"	BT-20	\$ 15.53
1-1/2"	BT-24	\$ 21.41
2"	BT-32	\$ 35.00

Brass Cross

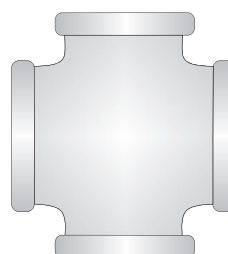

SIZE	PART NO.	PRICE
1/8"	BC-02	\$ 6.34
1/4"	BC-04	\$ 6.34
3/8"	BC-06	\$ 6.34
1/2"	BC-08	\$ 7.70
3/4"	BC-12	\$ 11.12
1"	BC-16	\$ 17.64
1-1/4"	BC-20	\$ 21.49
1-1/2"	BC-24	\$ 27.45
2"	BC-32	\$ 57.20

CITO-FP-PRICE-22-0812

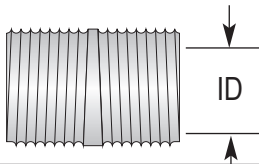

Pipe Nipples Brass 1 = 1/16"



	1/8" .296 ID	1/4" .364 ID	3/8" .493 ID	1/2" .622 ID	3/4" .824 ID	1" 1.049 ID	1-1/4" 1.380 ID	1-1/2" 1.610 ID	2" 2.067 ID
CLOSE	BN-02-01 \$.67	BN-04-01 \$.92	BN-06-01 \$ 1.28	BN-08-01 \$ 3.02	BN-12-01 \$ 5.11	BN-16-01 \$ 4.88	BN-20-01 \$ 7.34	BN-24-01 \$ 13.77	BN-32-01 \$ 14.51
2" LONG	BN-02-02 \$ 1.87	BN-04-02 \$ 2.02	BN-06-02 \$ 2.56	BN-08-02 \$ 3.22	BN-12-02 \$ 5.08	BN-16-02 \$ 6.01	BN-20-02 \$ 8.24	BN-24-02 \$ 10.28	BN-32-02 \$ 14.85
3" LONG	BN-02-03 \$ 2.18	BN-04-03 \$ 3.02	BN-06-03 \$ 4.07	BN-08-03 \$ 5.65	BN-12-03 \$ 5.58	BN-16-03 \$ 8.05	BN-20-03 \$ 15.30	BN-24-03 \$ 14.13	BN-32-03 \$ 14.06
4" LONG	BN-02-04 \$ 2.84	BN-04-04 \$ 3.37	BN-06-04 \$ 5.02	BN-08-04 \$ 5.69	BN-12-04 \$ 7.25	BN-16-04 \$ 10.53	BN-20-04 \$ 14.76	BN-24-04 \$ 14.32	BN-32-04 \$ 18.41
5" LONG	BN-02-05 \$ 3.37	BN-04-05 \$ 4.19	BN-06-05 \$ 4.91	BN-08-05 \$ 6.80	BN-12-05 \$ 8.68	BN-16-05 \$ 12.94	BN-20-05 \$ 18.00	BN-24-05 \$ 17.79	BN-32-05 \$ 22.75
6" LONG	BN-02-06 \$ 5.69	BN-04-06 \$ 5.11	BN-06-06 \$ 5.76	BN-08-06 \$ 8.26	BN-12-06 \$ 10.58	BN-16-06 \$ 7.34	BN-20-06 \$ 17.23	BN-24-06 \$ 21.14	BN-32-06 \$ 27.17

Due to fluctuating brass prices, please check for current prices.

Hose and Hose Clamps

Push-Loc Hose (No hose clamp required)



HOSE (ID)	PART NO.	PRICE PER FOOT
1/4"	PLH-4-*(R or B)	\$ 1.58
3/8"	PLH-6-*(R or B)	\$ 1.96
1/2"	PLH-8-*(R or B)	\$ 2.29
3/4"	PLH-12-*(R or B)	\$ 3.94
1"	PLH-16-*(R or B)	\$ 12.68

*Sold in 10' increments

*** SPECIFY COLOR:**

BLUE = B RED = R

MAXIMUM PRESSURE 150 P.S.I.

MAXIMUM TEMPERATURE 190° F

General Purpose Hose (Use with hose clamp)



*Sold in 10' increments

HOSE (ID)	PART NO.	PRICE PER FOOT
1-1/4"	GPH-20-*	\$ 5.02
1-1/2"	GPH-24-*	\$ 6.28
2"	GPH-32-*	\$ 9.86

*** SPECIFY COLOR:** BLACK = BLK RED = R

MAXIMUM PRESSURE 150 P.S.I.

MAXIMUM TEMPERATURE 190° F

Stainless Hose Clamps



DIAMETER RANGE	FOR	PART NO.	PRICE EACH
3/8" - 7/8"		SHC-6-14	\$ 1.78
7/16" - 1"		SHC-7-16	\$ 1.78
9/16" - 1-1/16"		SHC-9-17	\$ 1.78
11/16" - 1-1/2"		SHC-11-24	\$ 1.78
1-1/16" - 2"		SHC-17-32	\$ 1.85
1-9/16" - 2-1/2"		SHC-25-40	\$ 1.85

CITO-FP-PRICE-22-0817