

3/4" Inline™ Manifold - 1 = 1/4"

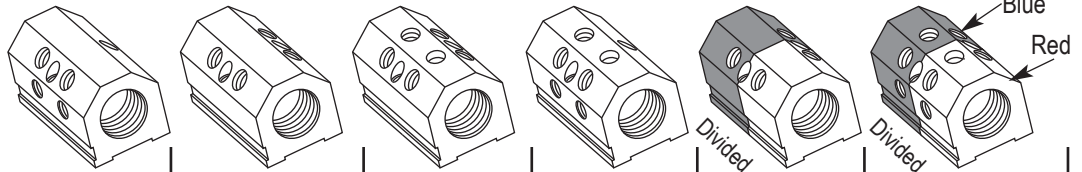

IM3-2-AB-4 1/8 or 1/4 \$60.00	IM3-2-BD-4 1/8 or 1/4 \$60.00	IM3-2-BCD-6 1/8 or 1/4 \$66.00	IM3-2-ABC-6 1/8 or 1/4 \$66.00	IM3-2-BD-2-2 1/8 or 1/4 \$74.00	IM3-2-ABCDE-5-5 1/8 \$92.00
-------------------------------------	-------------------------------------	--------------------------------------	--------------------------------------	---------------------------------------	-----------------------------------

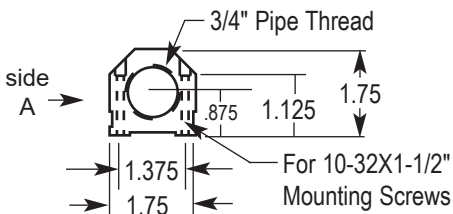
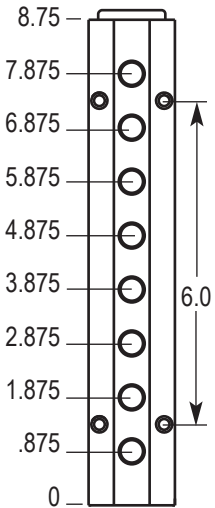
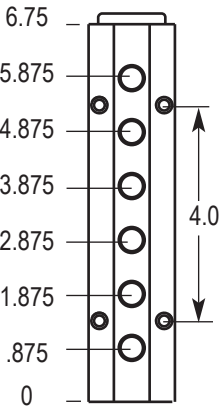
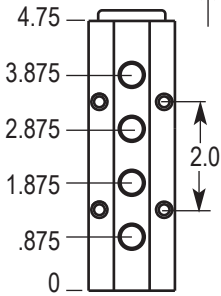
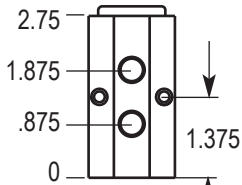
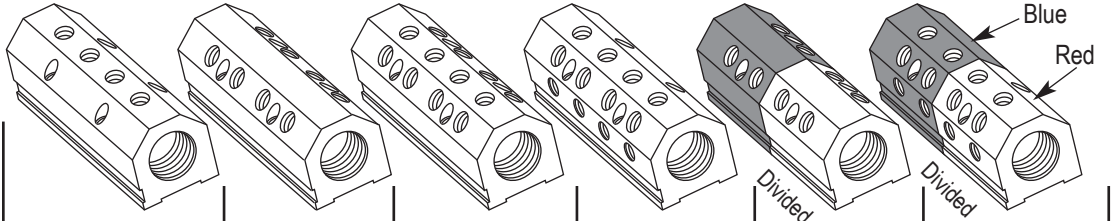

IM3-4-C-4 1/8 or 1/4 \$72.00	IM3-4-BD-8 1/8 or 1/4 \$84.00	IM3-4-BCD-12 1/8 or 1/4 \$84.00	IM3-4-ABC-12 1/8 or 1/4 \$96.00	IM3-4-BD-4-4 1/8 or 1/4 \$98.00	IM3-4-ABC-6-6 1/8 or 1/4 \$110.00
------------------------------------	-------------------------------------	---------------------------------------	---------------------------------------	---------------------------------------	---

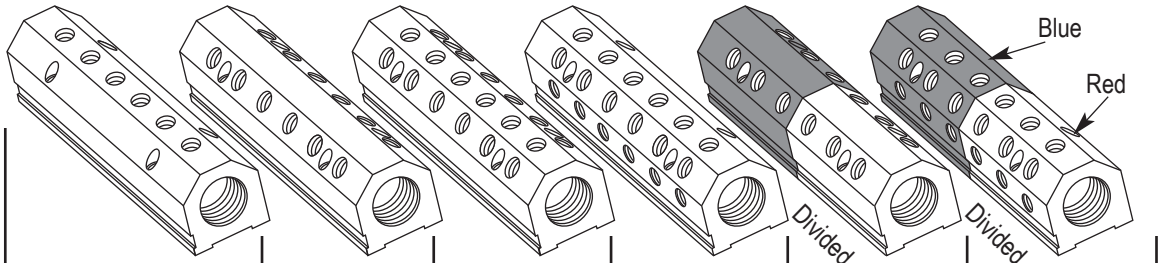

IM3-6-C-6 1/8 or 1/4 \$90.00	IM3-6-BD-12 1/8 or 1/4 \$108.00	IM3-6-BCD-18 1/8 or 1/4 \$126.00	IM3-6-ABC-18 1/8 or 1/4 \$126.00	IM3-6-BD-6-6 1/8 or 1/4 \$122.00	IM3-6-ABC-9-9 1/8 or 1/4 \$140.00
------------------------------------	---------------------------------------	--	--	--	---

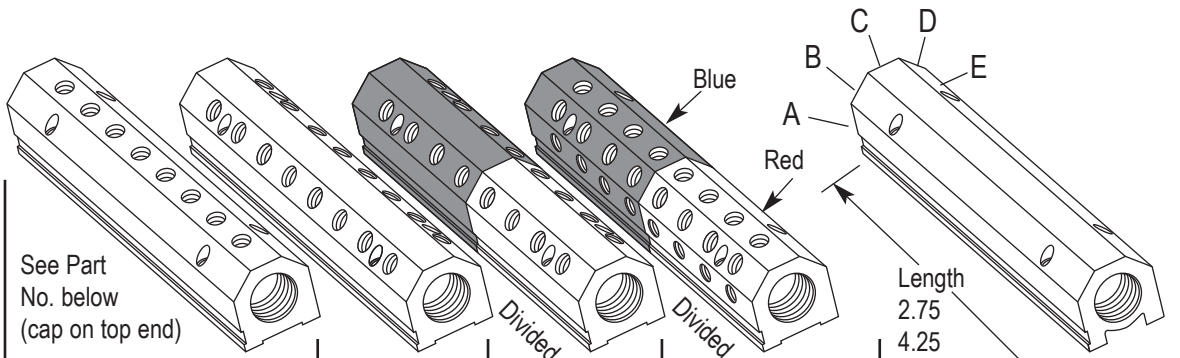

See Part No. below (cap on top end)

IM3-8-C-8 1/8 or 1/4 \$108.00	IM3-8-BD-16 1/8 or 1/4 \$132.00	IM3-8-BD-8-8 1/8 or 1/4 \$146.00	IM3-8-ABC-12-12 1/8 \$170.00
-------------------------------------	---------------------------------------	--	------------------------------------

PART NUMBER CODE:

IM3-8-C-8-1/4-N-BLUE

Red, Blue or Divided
Thread Type: N=NPT
1/4" "Out"
8 Holes
Row on side "C"
8 = 8.750" Overall Length
(3) x 1/4" = 3/4" Port
Inline Manifold

3/4" NPT

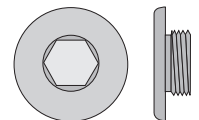

For Solid Color Manifolds
PRICES INCLUDE: End Cap and Stainless mounting screws.
ADDITIONAL 3/4" MANIFOLD END CAPS: IM-3030 - \$10.00 ea.
CUSTOM MANIFOLDS QUOTED UPON REQUEST

The anodized aluminum is not suitable for corrosive liquids (high chlorine content)

CITO-FP-PRICE-24-0124

1" Inline™ Manifold - 1 = 1/4"

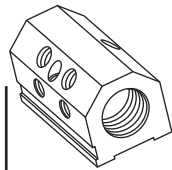
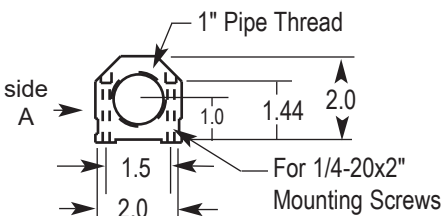
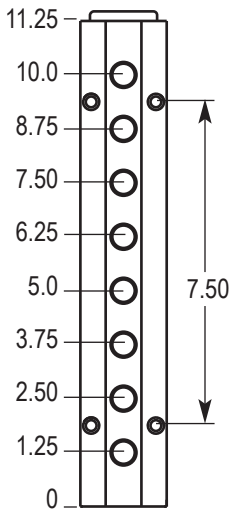
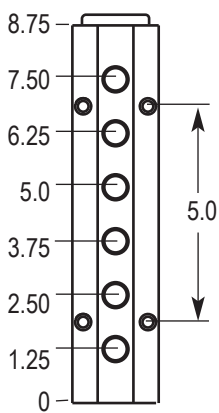
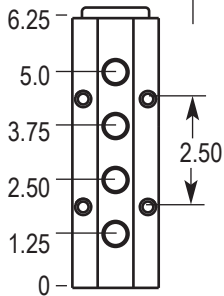
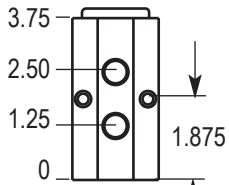

IM4-4-AB-4
1/4 or 3/8
\$72.00

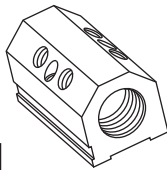

IM4-4-BD-4
1/4 or 3/8
\$72.00

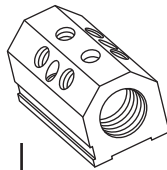

IM4-4-BCD-6
1/4 or 3/8
\$78.00

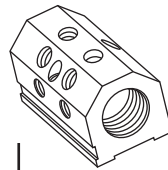

IM4-4-ABC-6
1/4 or 3/8
\$78.00

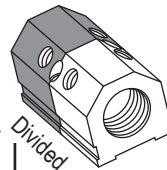

IM4-4-BD-2-2
1/4 or 3/8
\$90.00

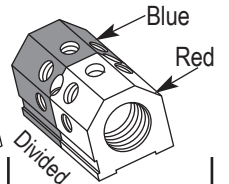

IM4-4-ABCDE-5-5
1/4
\$108.00

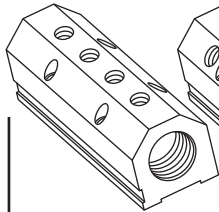

IM4-6-C-4
1/4 or 3/8
\$93.00

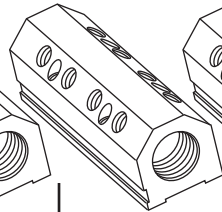

IM4-6-BD-8
1/4 or 3/8
\$105.00

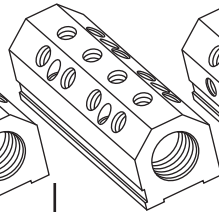

IM4-6-BCD-12
1/4 or 3/8
\$117.00

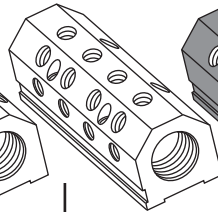

IM4-6-ABC-12
1/4 or 3/8
\$117.00

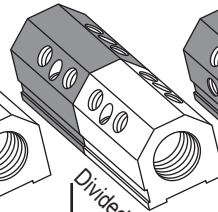

IM4-6-BD-4-4
1/4 or 3/8
\$123.00

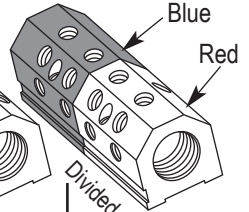

IM4-6-ABC-6-6
1/4 or 3/8
\$135.00

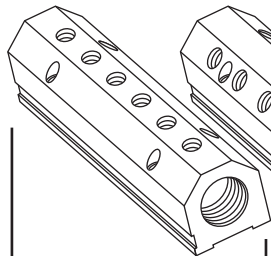

IM4-9-C-6
1/4 or 3/8
\$113.00

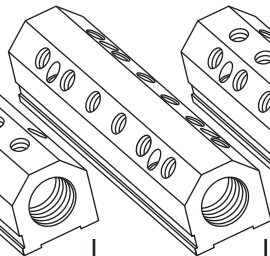

IM4-9-BD-12
1/4 or 3/8
\$131.00

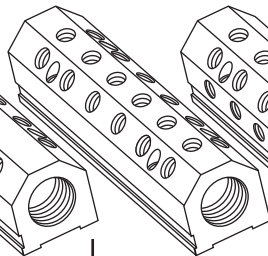

IM4-9-BCD-18
1/4 or 3/8
\$149.00

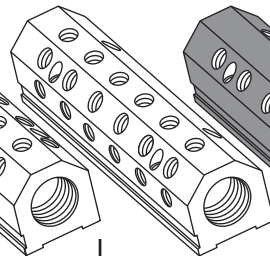

IM4-9-ABC-18
1/4 or 3/8
\$149.00

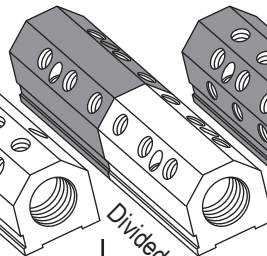

IM4-9-BD-6-6
1/4 or 3/8
\$149.00

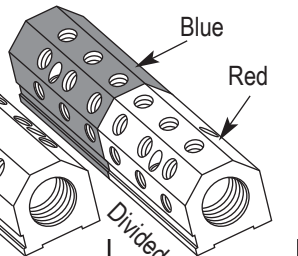

IM4-9-ABC-9-9
1/4 or 3/8
\$167.00

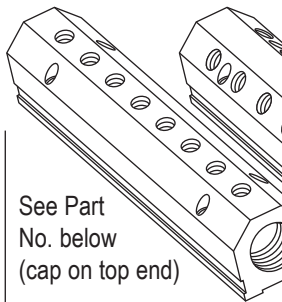

IM4-11-C-8
1/4 or 3/8
\$140.00

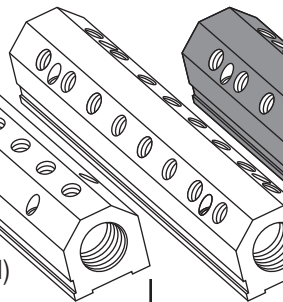

IM4-11-BD-16
1/4 or 3/8
\$164.00

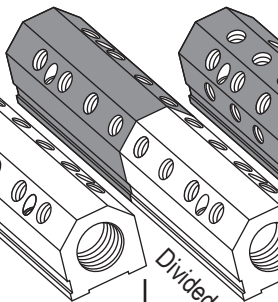

IM4-11-BD-8-8
1/4 or 3/8
\$182.00

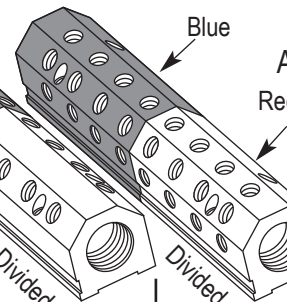

IM4-11-ABC-12-12
1/4 or 3/8
\$206.00

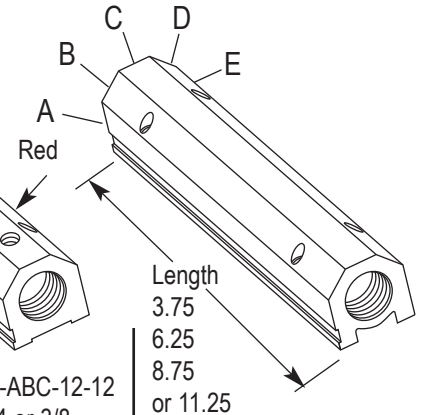

PART NUMBER CODE:

IM4-11-C-8-3/8-N-BLUE

Red, Blue or Divided
Thread Type: N=NPT
P=Mark BSPP
T=Mark BSPT
8 Holes
Row on side "C"
11 = 11.25" Overall Length
(4) x 1/4" = 1" Port
Inline Manifold

1" NPT

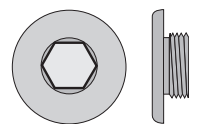

For Solid Color Manifolds
PRICES INCLUDE: End Cap and
Stainless mounting screws.
ADDITIONAL 1" MANIFOLD END
CAPS: IM-3040 - \$12.00 ea.
**CUSTOM MANIFOLDS
QUOTED UPON REQUEST**

The anodized aluminum is not suitable for corrosive liquids (high chlorine content)

1-1/4" Inline™ Manifold - 1 = 1/4"

Technical drawings on the left show manifold profiles with dimensions: 2.25, 3.0, 1.5, 0, 7.5, 6.0, 4.5, 3.0, 1.5, 0, 10.5, 9.0, 7.5, 6.0, 4.5, 3.0, 1.5, 0, 13.5, 12.0, 10.5, 9.0, 7.5, 6.0, 4.5, 3.0, 1.5, 0, and 9.0.

IM5-5-AB-4 1/4 or 3/8 \$92.00	IM5-5-BD-4 1/4 or 3/8 \$92.00	IM5-5-BCD-6 1/4 or 3/8 \$100.00	IM5-5-ABC-6 1/4 or 3/8 \$100.00	IM5-5-BD-2-2 1/4 or 3/8 \$110.00	IM5-5-ABCDE-5-5 1/4 or 3/8 \$134.00
IM5-8-C-4 1/4 or 3/8 \$116.00	IM5-8-BD-8 1/4 or 3/8 \$132.00	IM5-8-BCD-12 1/4 or 3/8 \$148.00	IM5-8-ABC-12 1/4 or 3/8 \$148.00	IM5-8-BD-4-4 1/4 or 3/8 \$150.00	IM5-8-ABC-6-6 1/4 or 3/8 \$166.00
IM5-11-C-6 1/4 or 3/8 \$148.00	IM5-11-BD-12 1/4 or 3/8 \$172.00	IM5-11-BCD-18 1/4 or 3/8 \$196.00	IM5-11-ABC-18 1/4 or 3/8 \$196.00	IM5-11-BD-6-6 1/4 or 3/8 \$190.00	IM5-11-ABC-9-9 1/4 or 3/8 \$214.00
IM5-14-C-8 1/4 or 3/8 \$180.00	IM5-14-BD-16 1/4 or 3/8 \$212.00	IM5-14-BD-8-8 1/4 or 3/8 \$230.00	IM5-14-ABC-12-12 1/4 or 3/8 \$262.00	See Part No. below (cap on top end)	

PART NUMBER CODE:
IM5-14-C-8-3/8-N-BLUE

- IM5 - In-line Manifold
- 14 - 14 = 13.5" Overall Length
- C - Row on side "C"
- 8 - 8 Holes
- 3/8 - 3/8" "Out"
- N - Thread Type: N=NPT
- BLUE - Red, Blue or Divided
- (5) x 1/4" = 1-1/4" Port

1-1/4" NPT

For Solid Color Manifolds
PRICES INCLUDE: End Cap and Stainless mounting screws.
ADDITIONAL 1-1/4" MANIFOLD END CAPS: IM-3050 - \$14.00 ea.
CUSTOM MANIFOLDS QUOTED UPON REQUEST

CITO-FP-PRICE-24-0213

The anodized aluminum is not suitable for corrosive liquids (high chlorine content)

1-1/2" Inline™ Manifold - 1 = 1/4"

6.0 4.0 2.0 0	IM6-6-AB-4 3/8 or 1/2 \$106.00	IM6-6-BD-4 3/8 or 1/2 \$106.00	IM6-6-BCD-6 3/8 or 1/2 \$116.00	IM6-6-ABC-6 3/8 or 1/2 \$116.00	IM6-6-BD-2-2 3/8 or 1/2 \$126.00	IM6-6-ABCDE-5-5 3/8 or 1/2 \$156.00
10.0 8.0 6.0 4.0 2.0 0	IM6-10-C-4 3/8 or 1/2 \$142.00	IM6-10-BD-8 3/8 or 1/2 \$162.00	IM6-10-BCD-12 3/8 or 1/2 \$182.00	IM6-10-ABC-12 3/8 or 1/2 \$182.00	IM6-10-BD-4-4 3/8 or 1/2 \$182.00	IM6-10-ABC-6-6 3/8 or 1/2 \$202.00
14.0 12.0 10.0 8.0 6.0 4.0 2.0 0	IM6-14-C-6 3/8 or 1/2 \$188.00	IM6-14-BD-12 3/8 or 1/2 \$218.00	IM6-14-BCD-18 3/8 or 1/2 \$248.00	IM6-14-ABC-18 3/8 or 1/2 \$248.00	IM6-14-BD-6-6 3/8 or 1/2 \$238.00	IM6-14-ABC-9-9 3/8 or 1/2 \$268.00
18.0 16.0 14.0 12.0 10.0 8.0 6.0 4.0 2.0 0	IM6-18-C-8 3/8 or 1/2 \$234.00	IM6-18-BD-16 3/8 or 1/2 \$274.00	IM6-18-BD-8-8 3/8 or 1/2 \$294.00	IM6-18-ABC-12-12 3/8 or 1/2 \$334.00	See Part No. below (cap on top end)	

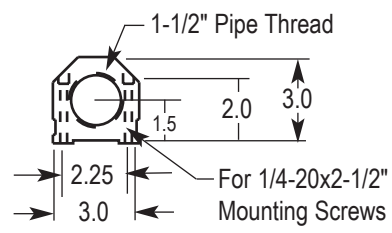

PART NUMBER CODE:
IM6-18-C-8-3/8-N-BLUE

- Red, Blue or Divided
- Thread Type: N=NPT
- 3/8" "Out"
- P=Mark BSPP
- T=Mark BSPT
- 8 Holes
- Row on side "C"
- 18 = 18" Overall Length
- (6) x 1/4" = 1-1/2" Port
- Inline Manifold

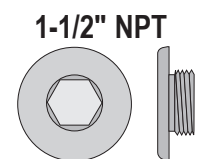

1-1/2" NPT

For Solid Color Manifolds
PRICES INCLUDE: End Cap and Stainless mounting screws.
ADDITIONAL 1-1/2" MANIFOLD END CAPS: IM-3060 - \$16.00 ea.
CUSTOM MANIFOLDS QUOTED UPON REQUEST

The anodized aluminum is not suitable for corrosive liquids (high chlorine content)

CITO-FP-PRICE-22-0812

2" Inline™ Manifold - 1 = 1/4"

Dimensions:

- Row 1: 7.0" total height, 3.5" port diameter, 0" to 4.75" port spacing.
- Row 2: 12.0" total height, 5.0" port diameter, 0" to 7.25" port spacing.
- Row 3: 17.0" total height, 10.0" port diameter, 0" to 12.25" port spacing.
- Row 4: 22.0" total height, 15.0" port diameter, 0" to 19.75" port spacing.

Part Numbers and Prices:

- IM8-8-ACE-6: 1/2, 3/4 or 1, \$154.00
- IM8-8-ABCDE-10: 1/2 or 3/4, \$178.00
- IM8-12-C-4: 1/2, 3/4 or 1, \$182.00
- IM8-12-BD-8: 1/2, 3/4 or 1, \$206.00
- IM8-12-ABC-12: 1/2 or 3/4, \$230.00
- IM8-12-ABC-6-6: 1/2 or 3/4, \$256.00
- IM8-17-C-6: 1/2, 3/4 or 1, \$244.00
- IM8-17-BD-12: 1/2, 3/4 or 1, \$280.00
- IM8-17-ABC-18: 1/2 or 3/4, \$316.00
- IM8-17-BD-6-6: 1/2, 3/4 or 1, \$306.00
- IM8-17-ABC-9-9: 1/2 or 3/4, \$342.00
- IM8-22-C-8: 1/2, 3/4 or 1, \$306.00
- IM8-22-BD-16: 1/2, 3/4 or 1, \$354.00
- IM8-22-BD-8-8: 1/2, 3/4 or 1, \$380.00
- IM8-22-ABC-12-12: 1/2 or 3/4, \$428.00

Color Options: Blue, Red, Divided

Thread Type: N=NPT, P=Mark BSPP, T=Mark BSPT

Part Number Code: IM8-22-C-6-1/2-N-BLUE

- IM8: Inline Manifold
- 22: 22" Overall Length
- C: Row on side "C"
- 6: 6 Holes
- 1/2: 1/2" "Out"
- N: Thread Type: N=NPT
- BLUE: Red, Blue or Divided

2" NPT

For Solid Color Manifolds
PRICES INCLUDE: End Cap and Stainless mounting screws.
ADDITIONAL 2" MANIFOLD END CAPS: IM-3080 - \$18.00 ea.
CUSTOM MANIFOLDS QUOTED UPON REQUEST

CITO-FP-PRICE-22-0812

The anodized aluminum is not suitable for corrosive liquids (high chlorine content)