

Inline™ Manifolds Ordering Information

Mold Mounted Manifolds provide many benefits to the operation and performance of the water cooled process. Our manifolds offer a myriad of combinations to suit your needs.

STANDARD MANIFOLDS

1. Choose your manifold from the following pages.
2. Stock Manifolds will ship same day or by the next business day.

WHEN ORDERING CUSTOM MANIFOLDS

1. Submit design or sketch.
2. Cito will make CAD drawing and submit via fax with price quote and delivery information.
3. Upon approval of drawing, the manifold will be shipped the following week.

TO ORDER YOUR DESIGN KIT FOR INLINE MANIFOLDS

Our Design Kit will assist in your mold or machine mounted design of Inline™ Manifolds — complete with CAD Patterns, and custom order forms.

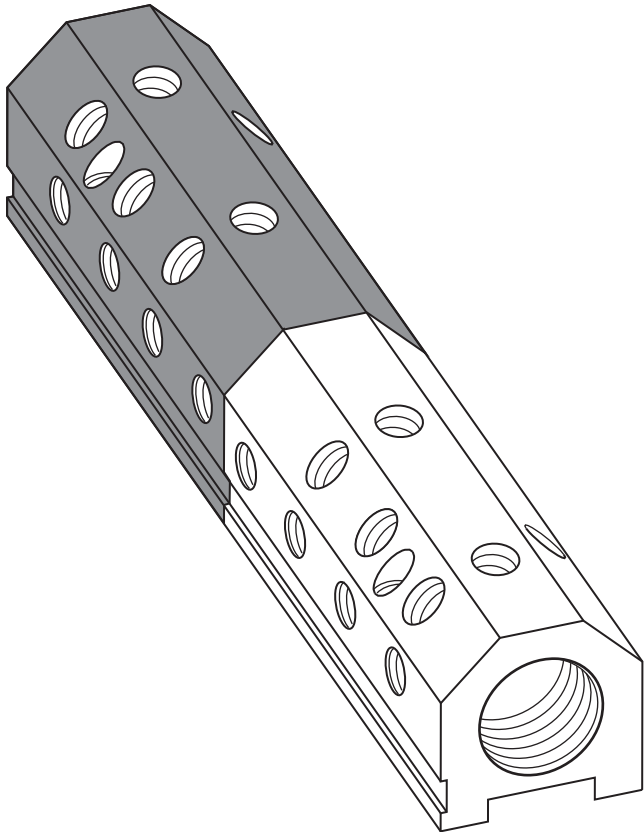

Please contact our Sales Department
CITO PRODUCTS INC.

N8779 County Road X • P.O. Box 90

Watertown, WI 53094 • USA

Phone: (920) 261-2606

Fax: (920) 261-1350

E-mail: sales@pulsecooling.com

ATTENTION: SALES DEPARTMENT

Please specify which CAD system you are using when requesting your Design Kit.

The Design Kit is available in:

.PRT (CadKey)

.DWG (AutoCad)

.DXF (Data Exchange Format)

.IGES (International Graphic Exchange)

The anodized aluminum is not suitable for corrosive liquids (high chlorine content).
Brass, steel and stainless is available. Request quote.

3/4" Inline™ Manifold (1 = 1/4")

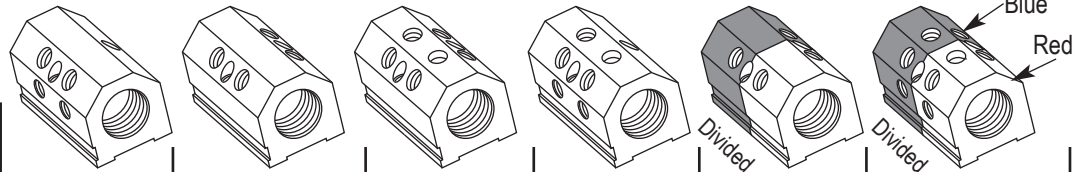
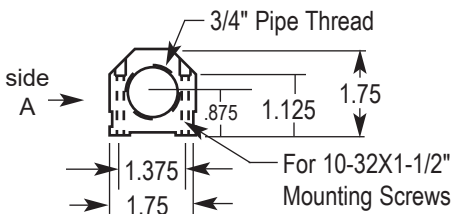
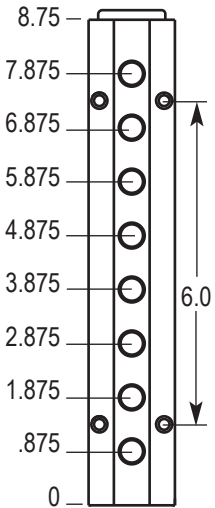
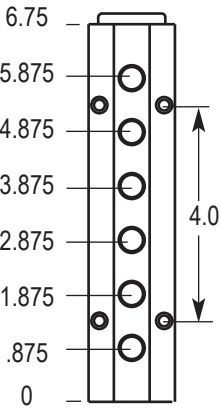
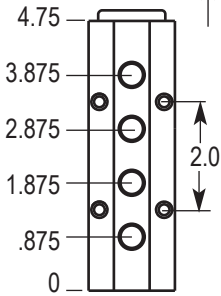
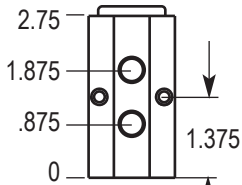

IM3-2-AB-4 1/8 or 1/4 \$72.00	IM3-2-BD-4 1/8 or 1/4 \$72.00	IM3-2-BCD-6 1/8 or 1/4 \$78.00	IM3-2-ABC-6 1/8 or 1/4 \$78.00	IM3-2-BD-2-2 1/8 or 1/4 \$83.00	IM3-2-ABCDE-5-5 1/8 \$101.00
-------------------------------------	-------------------------------------	--------------------------------------	--------------------------------------	---------------------------------------	------------------------------------

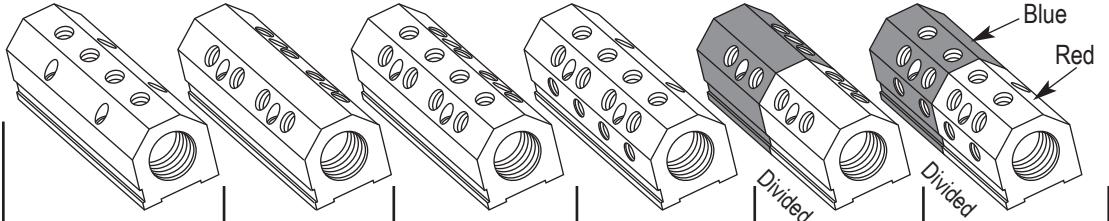

IM3-4-C-4 1/8 or 1/4 \$88.00	IM3-4-BD-8 1/8 or 1/4 \$100.00	IM3-4-BCD-12 1/8 or 1/4 \$112.00	IM3-4-ABC-12 1/8 or 1/4 \$112.00	IM3-4-BD-4-4 1/8 or 1/4 \$111.00	IM3-4-ABC-6-6 1/8 or 1/4 \$123.00
------------------------------------	--------------------------------------	--	--	--	---

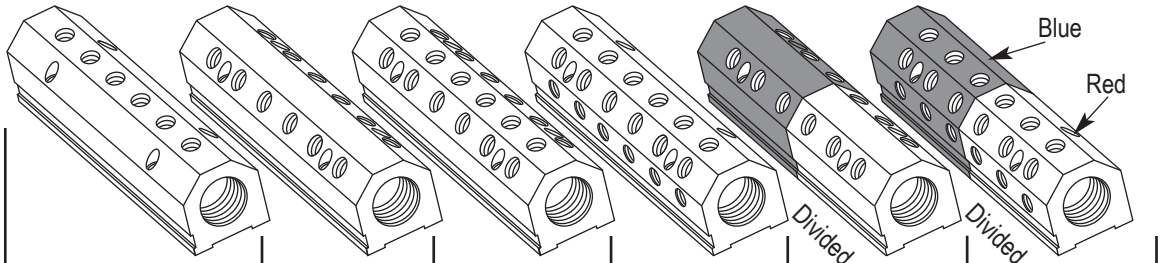

IM3-6-C-6 1/8 or 1/4 \$110.00	IM3-6-BD-12 1/8 or 1/4 \$128.00	IM3-6-BCD-18 1/8 or 1/4 \$146.00	IM3-6-ABC-18 1/8 or 1/4 \$146.00	IM3-6-BD-6-6 1/8 or 1/4 \$139.00	IM3-6-ABC-9-9 1/8 or 1/4 \$157.00
-------------------------------------	---------------------------------------	--	--	--	---

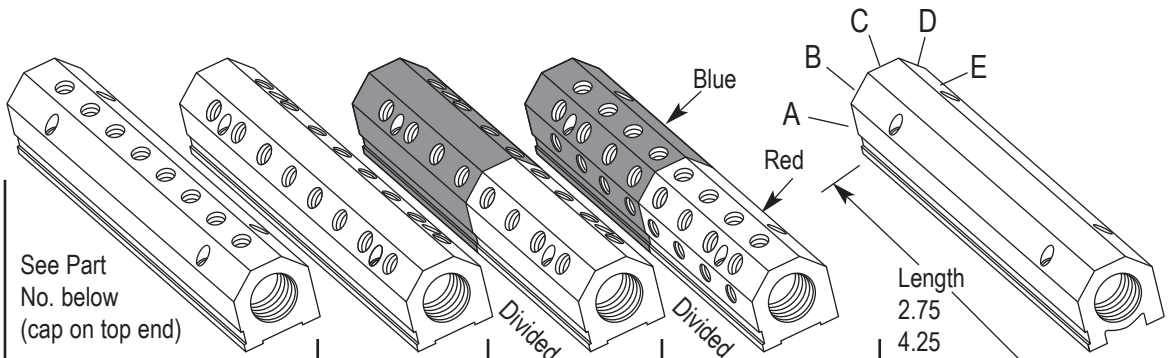

See Part No. below (cap on top end)

IM3-8-C-8 1/8 or 1/4 \$132.00	IM3-8-BD-16 1/8 or 1/4 \$156.00	IM3-8-BD-8-8 1/8 or 1/4 \$167.00	IM3-8-ABC-12-12 1/8 \$191.00
-------------------------------------	---------------------------------------	--	------------------------------------

PART NUMBER CODE:

IM3-8-C-8-1/4-N-R/B/D

Red, Blue or Divided
Thread Type: N = NPT
P = Mark BSPP
T = Mark BSPT

1/4" "Out"
8 Holes
Row on side "C"
8 = 8.750" Overall Length
(3) x 1/4" = 3/4" Port
Inline Manifold

3/4" NPT

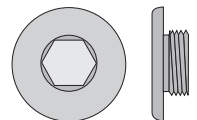

For Solid Color Manifolds
PRICES INCLUDE: End Cap and Stainless mounting screws.
ADDITIONAL 3/4" MANIFOLD END CAPS: IM-3030 - \$12.00 ea.
CUSTOM MANIFOLDS QUOTED UPON REQUEST

PC-PRICE-25-0129

The anodized aluminum is not suitable for corrosive liquids (high chlorine content)

1" Inline™ Manifold (1 = 1/4")

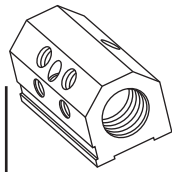
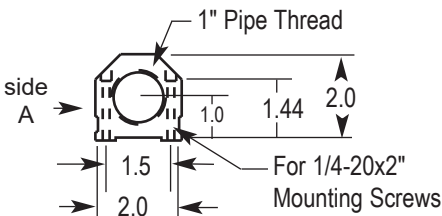
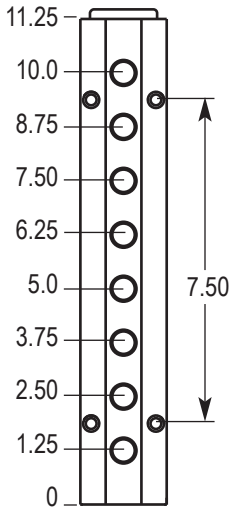
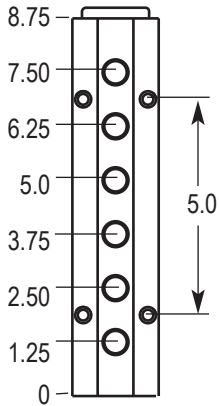
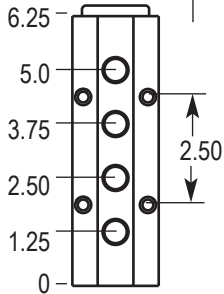
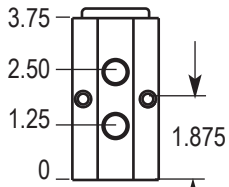

IM4-4-AB-4
1/4 or 3/8
\$88.00

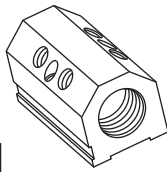

IM4-4-BD-4
1/4 or 3/8
\$88.00

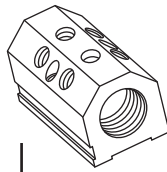

IM4-4-BCD-6
1/4 or 3/8
\$94.00

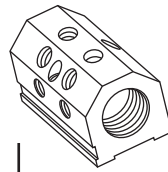

IM4-4-ABC-6
1/4 or 3/8
\$94.00

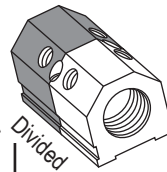

IM4-4-BD-2-2
1/4 or 3/8
\$101.00

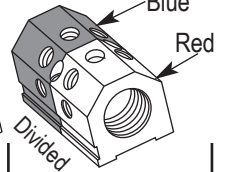

IM4-4-ABCDE-5-5
1/4
\$119.00

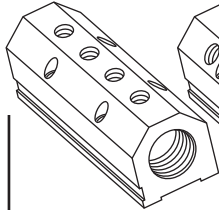

IM4-6-C-4
1/4 or 3/8
\$115.00

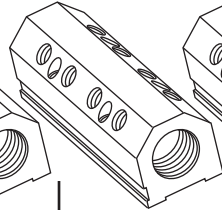

IM4-6-BD-8
1/4 or 3/8
\$127.00

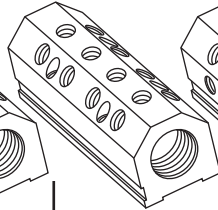

IM4-6-BCD-12
1/4 or 3/8
\$139.00

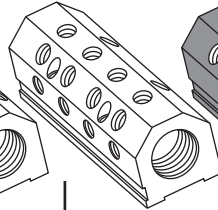

IM4-6-ABC-12
1/4 or 3/8
\$139.00

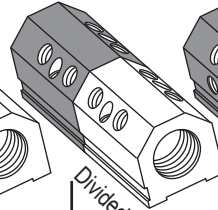

IM4-6-BD-4-4
1/4 or 3/8
\$140.00

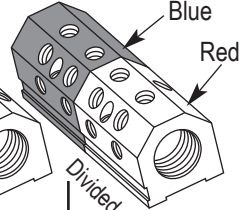

IM4-6-ABC-6-6
1/4 or 3/8
\$152.00

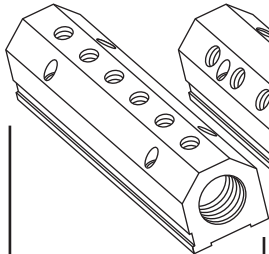

IM4-9-C-6
1/4 or 3/8
\$139.00

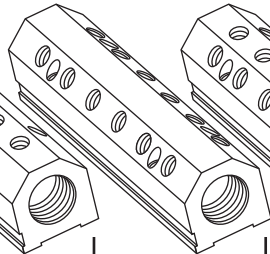

IM4-9-BD-12
1/4 or 3/8
\$157.00

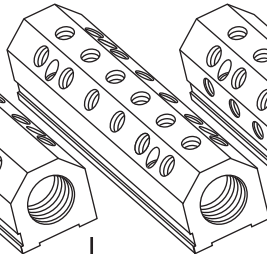

IM4-9-BCD-18
1/4 or 3/8
\$175.00

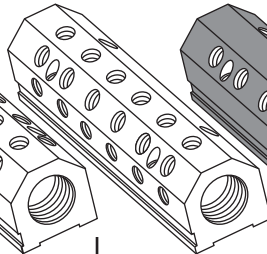

IM4-9-ABC-18
1/4 or 3/8
\$175.00

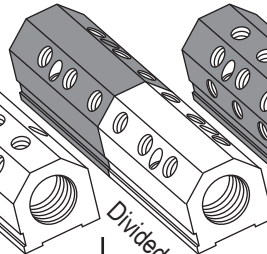

IM4-9-BD-6-6
1/4 or 3/8
\$170.00

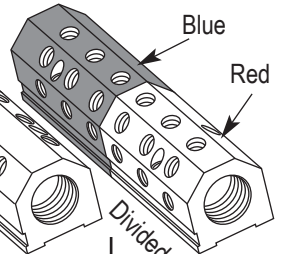

IM4-9-ABC-9-9
1/4 or 3/8
\$188.00

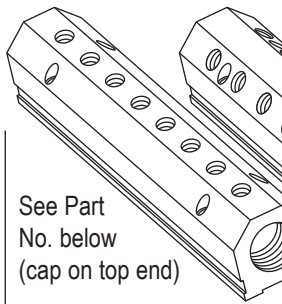

IM4-11-C-8
1/4 or 3/8
\$172.00

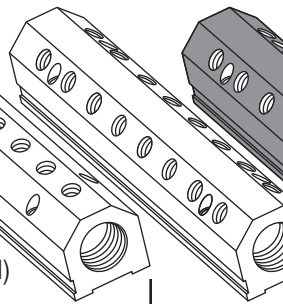

IM4-11-BD-16
1/4 or 3/8
\$196.00

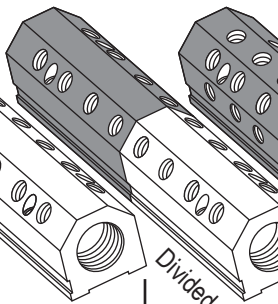

IM4-11-BD-8-8
1/4 or 3/8
\$209.00

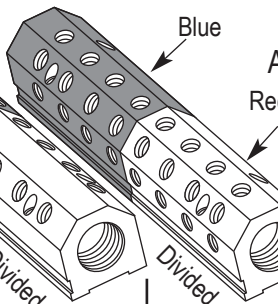

IM4-11-ABC-12-12
1/4 or 3/8
\$233.00

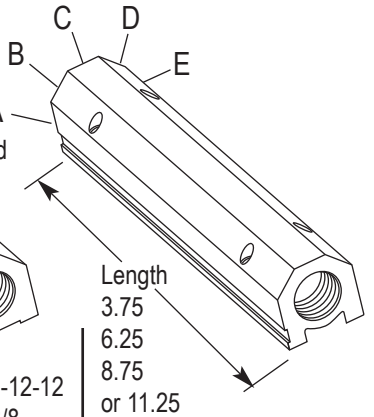

PART NUMBER CODE:

IM4-11-C-8-3/8-N-R/B/D

Red, Blue or Divided
Thread Type: N = NPT
P = Mark BSPP
T = Mark BSPT
8 Holes
Row on side "C"
11 = 11.25" Overall Length
(4) x 1/4" = 1" Port
Inline Manifold

1" NPT

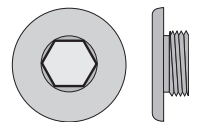

For Solid Color Manifolds
PRICES INCLUDE: End Cap and
Stainless mounting screws.
ADDITIONAL 1" MANIFOLD END
CAPS: IM-3040 - \$14.00 ea.
**CUSTOM MANIFOLDS
QUOTED UPON REQUEST**

PC-PRICE-25-0129

The anodized aluminum is not suitable for corrosive liquids (high chlorine content)

1-1/4" Inline™ Manifold (1 = 1/4")

IM5-5-AB-4 1/4 or 3/8 \$110.00	IM5-5-BD-4 1/4 or 3/8 \$110.00	IM5-5-BCD-6 1/4 or 3/8 \$118.00	IM5-5-ABC-6 1/4 or 3/8 \$118.00	IM5-5-BD-2-2 1/4 or 3/8 \$123.00	IM5-5-ABCDE-5-5 1/4 or 3/8 \$147.00
IM5-8-C-4 1/4 or 3/8 \$140.00	IM5-8-BD-8 1/4 or 3/8 \$156.00	IM5-8-BCD-12 1/4 or 3/8 \$172.00	IM5-8-ABC-12 1/4 or 3/8 \$172.00	IM5-8-BD-4-4 1/4 or 3/8 \$169.00	IM5-8-ABC-6-6 1/4 or 3/8 \$185.00
IM5-11-C-6 1/4 or 3/8 \$178.00	IM5-11-BD-12 1/4 or 3/8 \$202.00	IM5-11-BCD-18 1/4 or 3/8 \$226.00	IM5-11-ABC-18 1/4 or 3/8 \$226.00	IM5-11-BD-6-6 1/4 or 3/8 \$215.00	IM5-11-ABC-9-9 1/4 or 3/8 \$239.00
IM5-14-C-8 1/4 or 3/8 \$216.00	IM5-14-BD-16 1/4 or 3/8 \$248.00	IM5-14-BD-8-8 1/4 or 3/8 \$261.00	IM5-14-ABC-12-12 1/4 or 3/8 \$293.00	See Part No. below (cap on top end)	

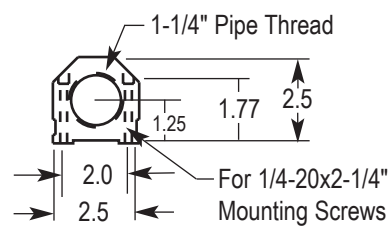

PART NUMBER CODE:
IM5-14-C-8-3/8-N-R/B/D

- Red, Blue or Divided
- Thread Type: N = NPT
- P = Mark BSPP
- T = Mark BSPT
- 3/8" "Out"
- 8 Holes
- Row on side "C"
- 14 = 13.5" Overall Length
- (5) x 1/4" = 1-1/4" Port

Inline Manifold

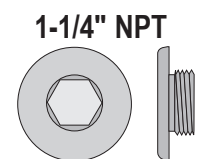

1-1/4" NPT

For Solid Color Manifolds
PRICES INCLUDE: End Cap and Stainless mounting screws.
ADDITIONAL 1-1/4" MANIFOLD END CAPS: IM-3050 - \$16.00 ea.
CUSTOM MANIFOLDS QUOTED UPON REQUEST

PC-PRICE-25-0129

The anodized aluminum is not suitable for corrosive liquids (high chlorine content)

1-1/2" Inline™ Manifold (1 = 1/4")

Technical drawings on the left show manifold profiles with dimensions: 3.0, 4.0, 8.0, 12.0, and 18.0 inches in length, and 6.0, 10.0, 14.0, and 18.0 inches in height. A detailed view at the bottom left shows a 1-1/2" pipe thread, 2.25 inch width, 3.0 inch height, and 1.5 inch offset for mounting screws.

<p>IM6-6-AB-4 3/8 or 1/2 \$120.00</p>	<p>IM6-6-BD-4 3/8 or 1/2 \$120.00</p>	<p>IM6-6-BCD-6 3/8 or 1/2 \$130.00</p>	<p>IM6-6-ABC-6 3/8 or 1/2 \$130.00</p>	<p>IM6-6-BD-2-2 3/8 or 1/2 \$138.00</p>	<p>IM6-6-ABCDE-5-5 3/8 or 1/2 \$168.00</p>
<p>IM6-10-C-4 3/8 or 1/2 \$160.00</p>	<p>IM6-10-BD-8 3/8 or 1/2 \$180.00</p>	<p>IM6-10-BCD-12 3/8 or 1/2 \$200.00</p>	<p>IM6-10-ABC-12 3/8 or 1/2 \$200.00</p>	<p>IM6-10-BD-4-4 3/8 or 1/2 \$198.00</p>	<p>IM6-10-ABC-6-6 3/8 or 1/2 \$218.00</p>
<p>IM6-14-C-6 3/8 or 1/2 \$224.00</p>	<p>IM6-14-BD-12 3/8 or 1/2 \$254.00</p>	<p>IM6-14-BCD-18 3/8 or 1/2 \$284.00</p>	<p>IM6-14-ABC-18 3/8 or 1/2 \$284.00</p>	<p>IM6-14-BD-6-6 3/8 or 1/2 \$272.00</p>	<p>IM6-14-ABC-9-9 3/8 or 1/2 \$302.00</p>
<p>IM6-18-C-8 3/8 or 1/2 \$282.00</p>	<p>IM6-18-BD-16 3/8 or 1/2 \$322.00</p>	<p>IM6-18-BD-8-8 3/8 or 1/2 \$340.00</p>	<p>IM6-18-ABC-12-12 3/8 or 1/2 \$380.00</p>	<p>Length 6.0 10.0 14.0 or 18.0</p>	

See Part No. below (cap on top end)

PART NUMBER CODE:
IM6-18-C-8-3/8-N-R/B/D
 Red, Blue or Divided
 Thread Type: N = NPT
 P = Mark BSPP
 T = Mark BSPT
 3/8" "Out"
 8 Holes
 Row on side "C"
 18 = 18" Overall Length
 (6) x 1/4" = 1-1/2" Port
 Inline Manifold

1-1/2" NPT

For Solid Color Manifolds
PRICES INCLUDE: End Cap and Stainless mounting screws.
ADDITIONAL 1-1/2" MANIFOLD END CAPS: IM-3060 - \$18.00 ea.
CUSTOM MANIFOLDS QUOTED UPON REQUEST

PC-PRICE-25-0129

The anodized aluminum is not suitable for corrosive liquids (high chlorine content)

2" Inline™ Manifold (1 = 1/4")

Dimensions:

- Row height: 3.5" (for 1/4" ports), 5.0" (for 3/4" ports), 10.0" (for 1" ports)
- Overall length options: 8.0", 12.0", 17.0", or 22.0"
- Port diameter: 1/2", 3/4", or 1"

Part Numbers and Prices:

- IM8-8-ACE-6: 1/2, 3/4 or 1, \$176.00
- IM8-8-ABCDE-10: 1/2 or 3/4, \$200.00
- IM8-12-C-4: 1/2, 3/4 or 1, \$212.00
- IM8-12-BD-8: 1/2, 3/4 or 1, \$236.00
- IM8-12-ABC-12: 1/2 or 3/4, \$260.00
- IM8-12-ABC-6-6: 1/2 or 3/4, \$283.00
- IM8-17-C-6: 1/2, 3/4 or 1, \$285.00
- IM8-17-BD-12: 1/2, 3/4 or 1, \$321.00
- IM8-17-ABC-18: 1/2 or 3/4, \$357.00
- IM8-17-BD-6-6: 1/2, 3/4 or 1, \$344.00
- IM8-17-ABC-9-9: 1/2 or 3/4, \$380.00
- IM8-22-C-8: 1/2, 3/4 or 1, \$358.00
- IM8-22-BD-16: 1/2, 3/4 or 1, \$406.00
- IM8-22-BD-8-8: 1/2, 3/4 or 1, \$429.00
- IM8-22-ABC-12-12: 1/2 or 3/4, \$477.00

Color Options: Blue, Red, Divided

Part Number Code:
IM8-22-C-6-1/2-N-R / B / D

- IM8: Inline Manifold
- 22: 22" Overall Length
- C: Row on side "C"
- 6: 6 Holes
- 1/2: 1/2" "Out"
- N: Thread Type: N = NPT
- R: Red, Blue or Divided
- B: Mark BSPP
- D: Mark BSPT

2" NPT

For Solid Color Manifolds
PRICES INCLUDE: End Cap and Stainless mounting screws.
ADDITIONAL 2" MANIFOLD END CAPS: IM-3080 - \$20.00 ea.
CUSTOM MANIFOLDS QUOTED UPON REQUEST

PC-PRICE-25-0129

The anodized aluminum is not suitable for corrosive liquids (high chlorine content)