

RotoLine™ Flow Indicating Manifold

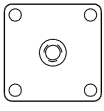

(1) 1/8" EC-2011

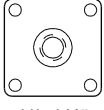

(1) 1/4" EC-2021

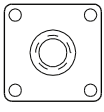

(1) 3/8" EC-2031

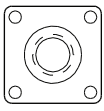

(1) 1/2" EC-2041

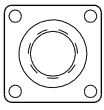

(1) 3/4" EC-2061

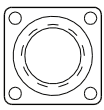

(1) 1" EC-2081

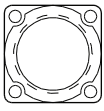

(1) 1-1/4" EC-2101

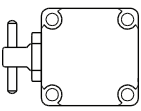

Valve Cap
1/4" - VC-2902
3/8" - VC-2903
1/2" - VC-2904

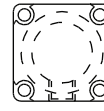
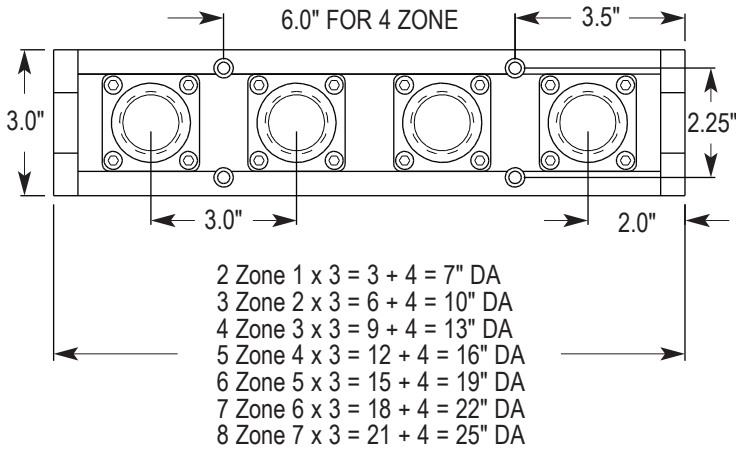

1/4" Side EC-220S

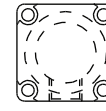

3/8" Side EC-230S

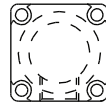

1/2" Side EC-240S

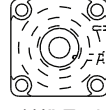

1/4" End EC-22TE-TCK

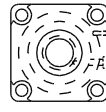

3/8" End EC-23TE-TCK

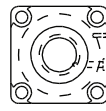

1/2" End EC-24TE-TCK

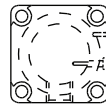

1/4" End EC-22TS-TCK

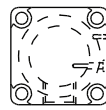

3/8" Side EC-23TS-TCK

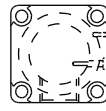

1/2" Side EC-24TS-TCK

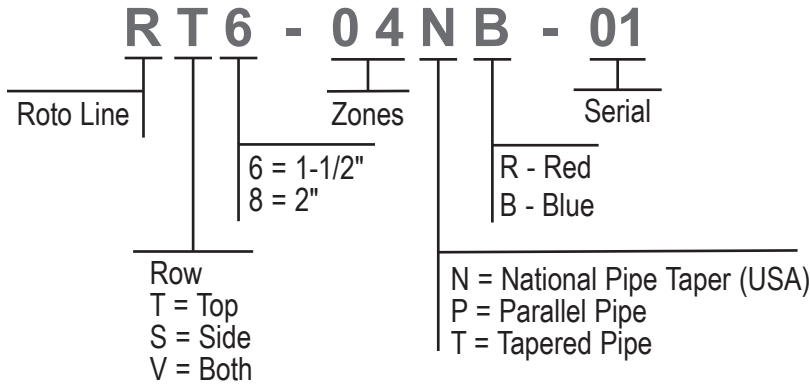
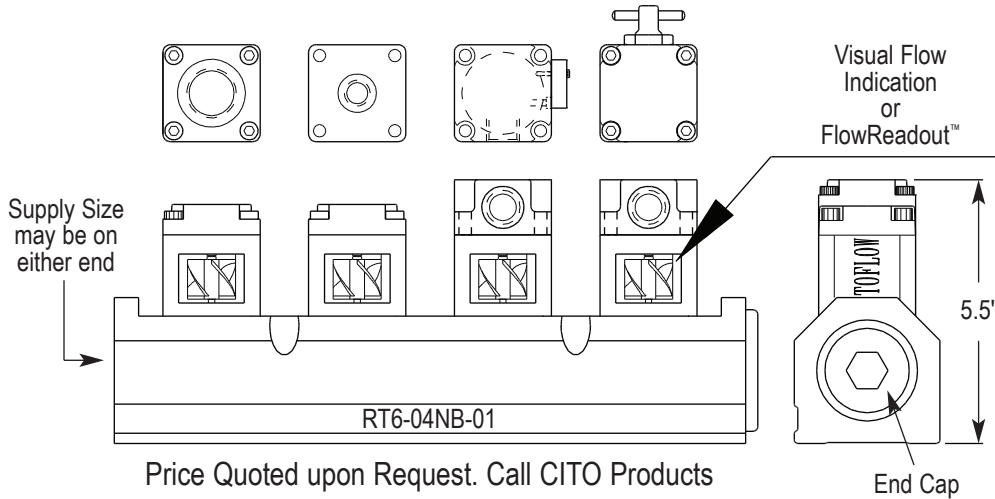

CITO PRODUCTS
WILL ASSIGN MODEL NUMBER TO EACH CUSTOM ASSEMBLY

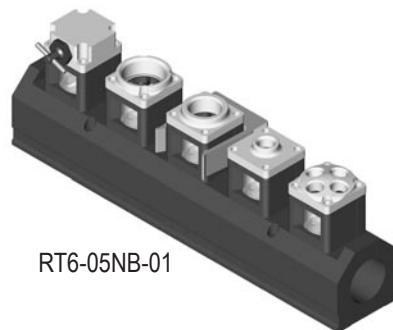

CITO-FP-PRICE-22-1004