

Suggested Sensor Selection

CITO PRODUCTS HAS DEVELOPED A SERIES OF SENSORS

SUITABLE FOR A WIDE RANGE OF APPLICATIONS

THE SENSOR TIP SHOULD BE PLACED AT A DYNAMIC POSITION.

TO CHECK THE SENSOR - USE AN OHM METER. THE RESISTANCE SHOULD READ 20.000 OHM @ 77 DEGR F.(25C) AS THE TEMPERATURE INCREASES - THE RESISTANCE WILL DECREASE.

THE LENGTH OF THE CONNECTION CABLE MAY BE EXTENDED TO ANY LENGTH WITH MINIMAL CHANGE IN PERFORMANCE.

FOR CUSTOM SENSOR ASSEMBLIES - CONTACT FACTORY

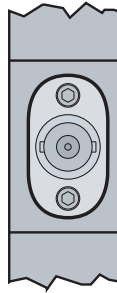

42

SPRING PLATE PROBE 3/16" WITH 3/16" SENSOR GUIDETUBE FOR 90 DEGR. TURNS

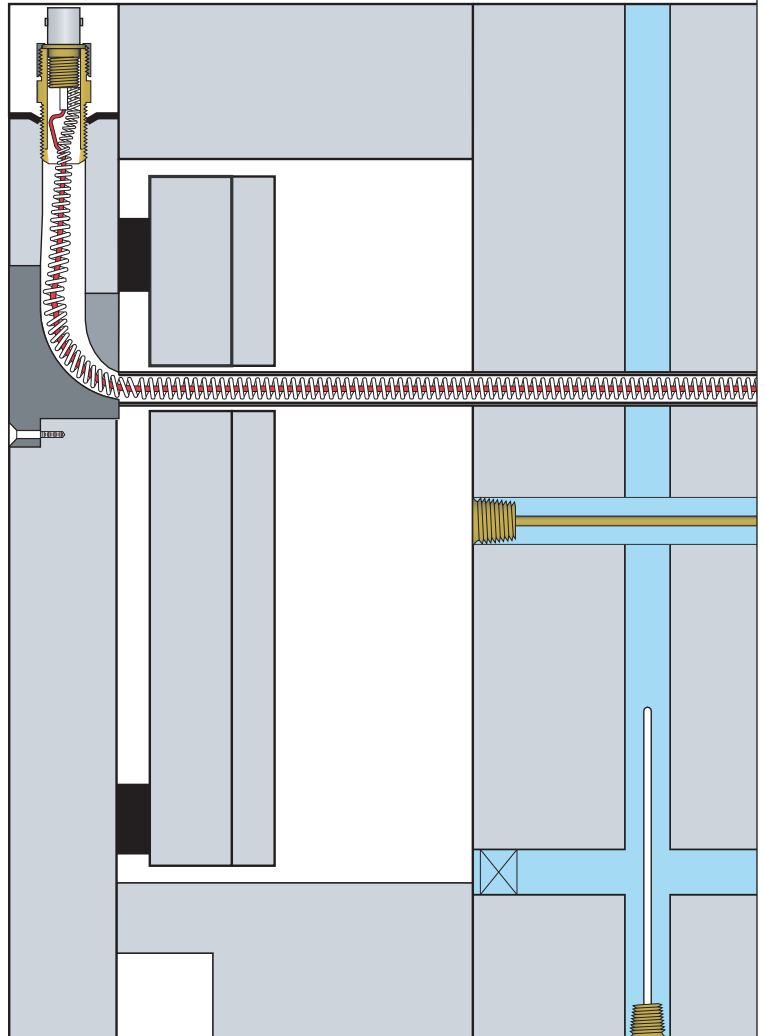

PC-PRICE-25-0204

Select a sensor that can be installed closest to the area that needs to be controlled.

Ideal distance
0.1" from Molding Surface

80

INTERNAL WET PROBE

Use with
"Pulse Advance"
Controller

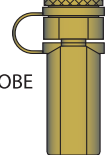

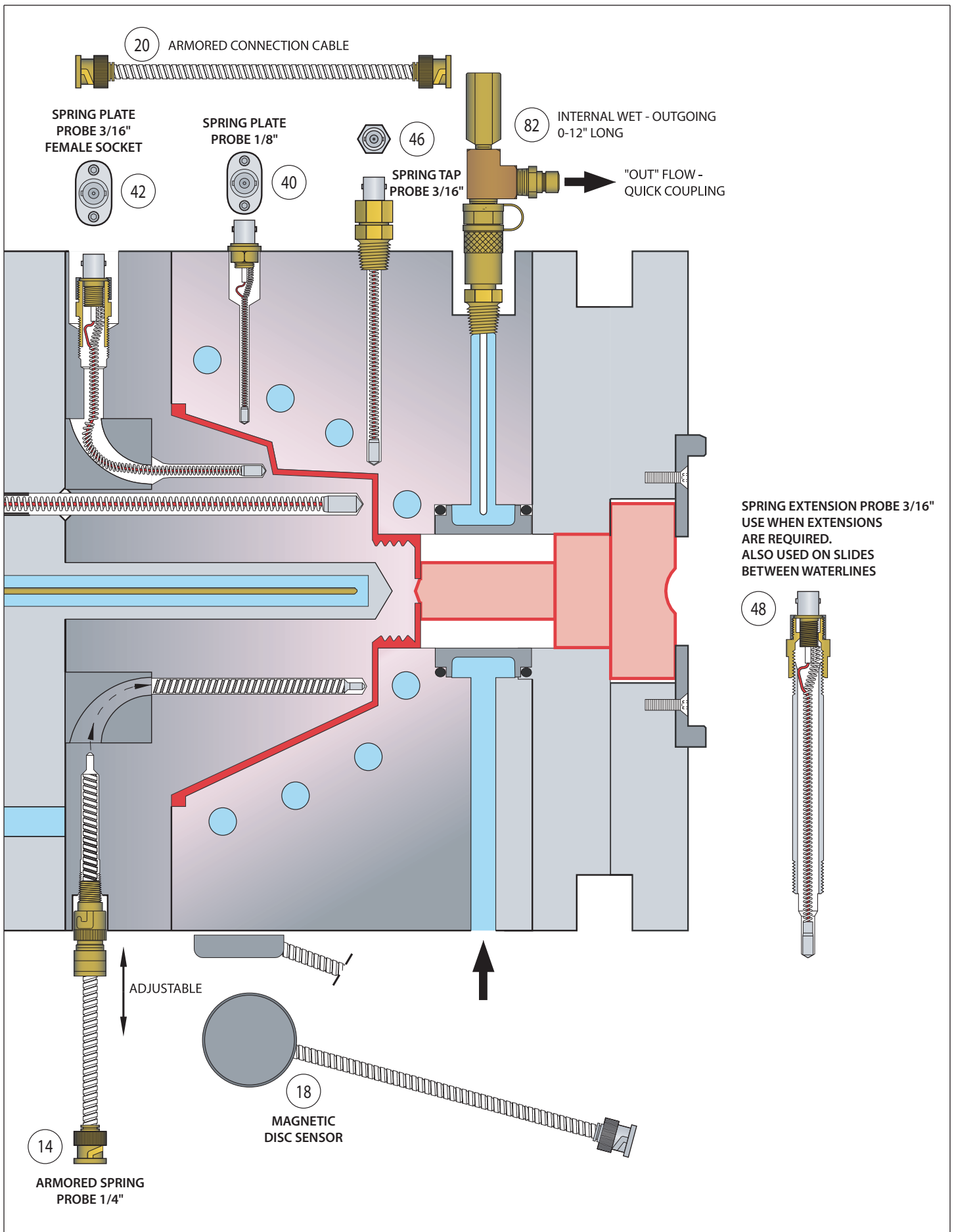

Armored Spring Probes - Custom Sizes - Request Quote

10 Armored Mini Probe 1/8", 1/8" X .5" Long Tip (CAD: AMP-2-20-XXX)

SENSOR SELECTION: PC-1000
MFG. DWG. ASP-1200
ASP-1220
INSTALL. ASP-1800

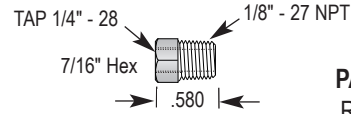
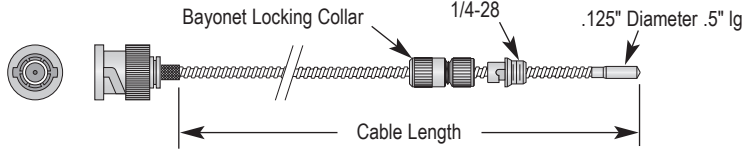

Reducer for Armored Spring
Probe to fit 1/8" NPT

PART NO.	PRICE
RB-04-28	\$ 2.80

BODY DIA.	CABLE LENGTH	PART NO.	PRICE
2 = 1/8"	12"	AMP-2-20-012	\$106.00
	24"	AMP-2-20-024	\$110.00
	36"	AMP-2-20-036	\$114.00
	48"	AMP-2-20-048	\$118.00

12 Armored Bayonet Probe 3/16", 1/8" X .3" Long Tip (CAD: ASP-4-20-XXX)

SENSOR SELECTION: PC-1000
MFG. DWG. ASP-1200
ASP-1220
INSTALL. ASP-1800

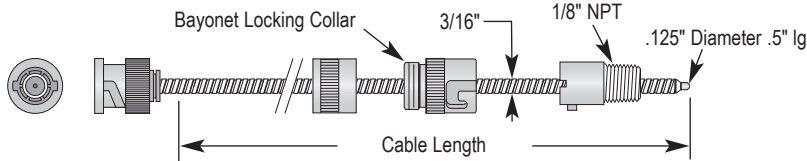

BODY DIA.	CABLE LENGTH	PART NO.	PRICE
3 = 3/16"	12"	ABP-3-20-012	\$106.00
	24"	ABP-3-20-024	\$110.00
	36"	ABP-3-20-036	\$114.00
	48"	ABP-3-20-048	\$118.00

14 Armored Spring Probe 1/4", 1/8" X .3" Long Tip (CAD: ASP-4-20-XXX)

SENSOR SELECTION: PC-1000
INSTALL. ASP-1800

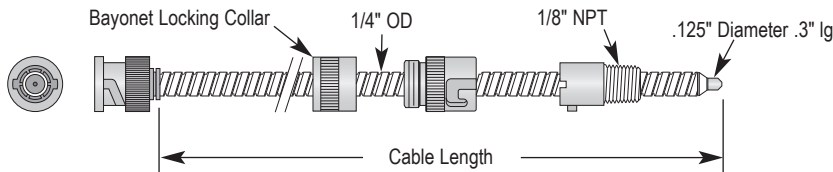

BODY DIA.	CABLE LENGTH	PART NO.	PRICE
4 = 1/4"	36"	ASP-4-20-036	\$110.00
	48"	ASP-4-20-048	\$114.00
	60"	ASP-4-20-060	\$118.00
	72"	ASP-4-20-072	\$122.00
	96"	ASP-4-20-096	\$130.00
	120"	ASP-4-20-120	\$140.00

To make a 90° change in direction use
sensor guide insert SGI-8-1500-2

16 Armored Long Probe 1/4", 1/8" X 1" Long Tip (CAD: ALP-4-20-XXX)

SENSOR SELECTION: PC-1000
MFG. DWG. ALP-1200
ASP-1220
INSTALL. ASP-1800

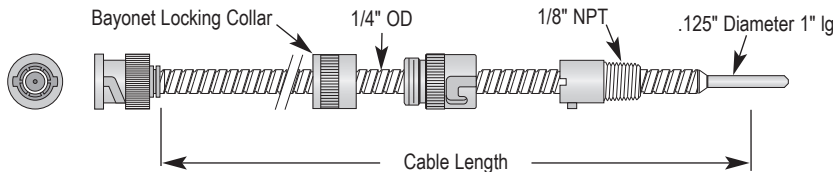

BODY DIA.	CABLE LENGTH	PART NO.	PRICE
4 = 1/4"	36"	ALP-4-20-036	\$112.00
	48"	ALP-4-20-048	\$116.00
	60"	ALP-4-20-060	\$120.00
	72"	ALP-4-20-072	\$124.00
	96"	ALP-4-20-096	\$132.00
	120"	ALP-4-20-120	\$140.00

NOTE: Do not use with
Sensor Guide Insert

18 Magnetic Disc Sensor

SENSOR SELECTION: PC-1000

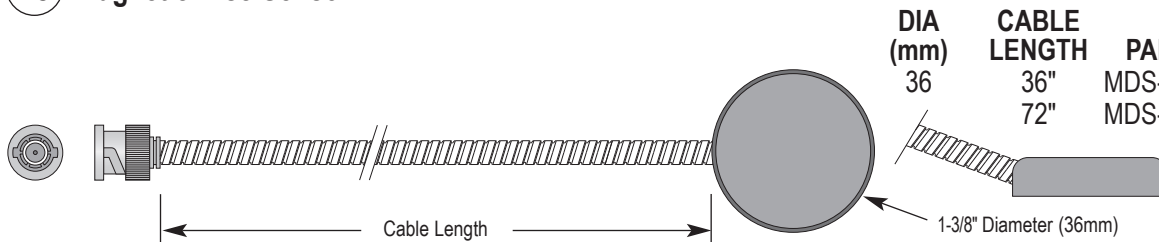

DIA (mm)	CABLE LENGTH	PART NO.	PRICE
36	36"	MDS-36-20-36	\$128.00
	72"	MDS-36-20-72	\$134.00

Connection Cables

20 Armored Connection Cable

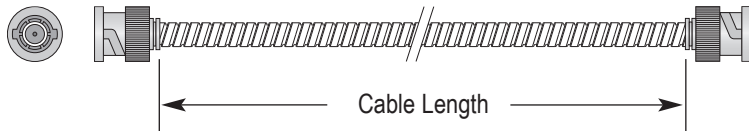

22 Connection Coupling

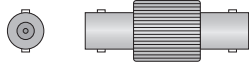

PART NO. BNC-CC
PRICE \$ 11.00

MFG. DWG. ACC-1200

CABLE LENGTH	PART NO.	PRICE
12"	ACC-BB-012	\$ 70.00
24"	ACC-BB-024	\$ 75.00
36"	ACC-BB-036	\$ 80.00
48"	ACC-BB-048	\$ 85.00
60"	ACC-BB-060	\$ 90.00
96"	ACC-BB-096	\$ 105.00
120"	ACC-BB-120	\$ 115.00
144"	ACC-BB-144	\$ 125.00

Spring Probes (1 = 1/16")

40 Spring Plate Probe 1/8" (CAD: SPP-2-20-XX)

SENSOR SELECTION: PC-1000
(BLUE) INSTALL. SPP-1800

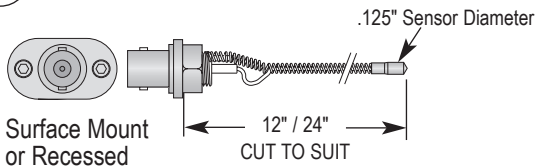

Use with Sensor Guide Insert SGI-6-875-1.5

Use with type "ACC" Extension Cable

DIA.	LENGTH	PART NO.	PRICE
2 = 1/8"	12"	SPP-2-20-12	\$ 94.00
	24"	SPP-2-20-24	\$ 98.00

42 Spring Plate Probe 3/16" (CAD: SPP-3-20-XX)

SENSOR SELECTION: PC-1000
(YELLOW) INSTALL. SPP-1800

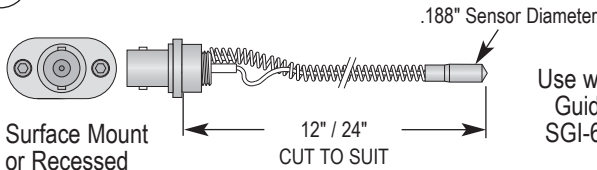

Use with Sensor Guide Insert SGI-6-875-1.5

Use with type "ACC" Extension Cable

DIA.	LENGTH	PART NO.	PRICE
3 = 3/16"	12"	SPP-3-20-12	\$ 96.00
	24"	SPP-3-20-24	\$ 98.00

44 Spring Tap Probe 1/8" - 1/4" NPT (CAD: STP-2-20-XX)

SENSOR SELECTION: PC-1000
MFG. DWG. STP-1202
(GREEN) INSTALL. STP-1800

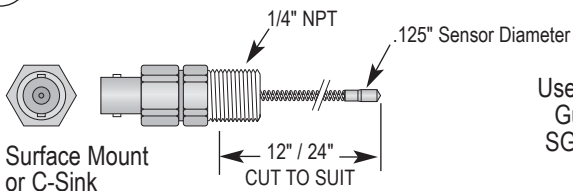

Use with Sensor Guide Insert SGI-6-875-1.5

Use with type "ACC" Extension Cable

DIA.	LENGTH	PART NO.	PRICE
2 = 1/8"	12"	STP-2-20-12	\$ 96.00
	24"	STP-2-20-24	\$ 98.00

46 Spring Tap Probe 3/16" - 1/4" NPT (CAD: STP-3-20-XX)

SENSOR SELECTION: PC-1000
(PINK) INSTALL. STP-1800

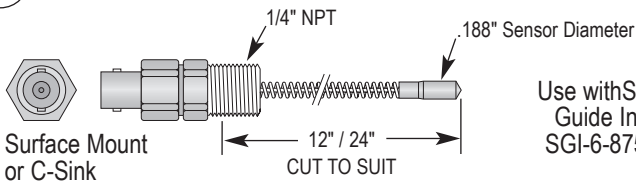

Use with Sensor Guide Insert SGI-6-875-1.5

Use with type "ACC" Extension Cable

DIA.	LENGTH	PART NO.	PRICE
3 = 3/16"	12"	STP-3-20-12	\$ 96.00
	24"	STP-3-20-24	\$ 98.00

48 Spring Extension Probe 3/16" - 1/4" NPT (CAD: SEP-3-PX-20-XX)

SENSOR SELECTION: PC-1000
MFG. DWG. SEP-1200

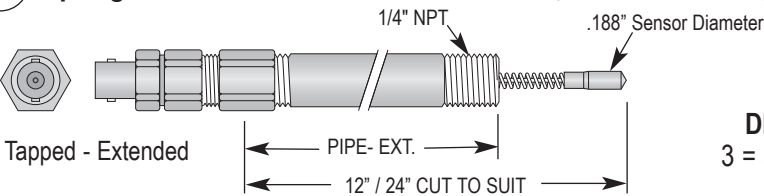

DIA.	PIPE EXT.	LENGTH (XX)	PART NO.	PRICE
3 = 3/16"	P4 = 4"	12"	SEP-3-P4-20-12	\$ 98.00

Use with type "ACC" Extension Cable

If You Are Not Set up For This Operation - Specify Length and We Will Provide Complete Ass'y. Specify Depth of Hole to Mold Surface - \$30 / Ass'y

PC-PRICE-25-0114

Internal Wet Temperature Sensors (1 = 1/16")

SENSOR SELECTION: PC-1000
MFG. DWG. IWA-1200
INSTALL. IWA-1800

60 Internal Wet - Adjustable (CAD: IWS-X-20-XX-XXX)

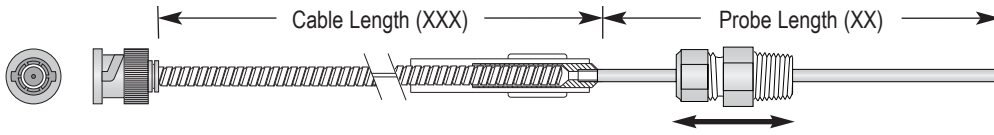

FITTING SIZE	PROBE LENGTH	CABLE LENGTH	PART NO.	**BASE PRICE	PART NO.	**BASE PRICE	PART NO.	**BASE PRICE
2 = 1/8"	03 = 3"	48"	IWA-2-20-03-048	\$132.00	IWA-4-20-03-048	\$136.00	IWA-6-20-03-048	\$140.00
4 = 1/4"	06 = 6"	72"	IWA-2-20-03-072	\$140.00	IWA-4-20-03-072	\$144.00	IWA-6-20-03-072	\$148.00
6 = 3/8"	09 = 9"		IWA-2-20-06-048	\$148.00	IWA-4-20-06-048	\$152.00	IWA-6-20-06-048	\$156.00
			IWA-2-20-06-072	\$158.00	IWA-4-20-06-072	\$162.00	IWA-6-20-06-072	\$166.00
			IWA-2-20-09-048	\$166.00	IWA-4-20-09-048	\$170.00	IWA-6-20-06-048	\$174.00
			IWA-2-20-09-072	\$174.00	IWA-4-20-09-072	\$178.00	IWA-6-20-06-072	\$182.00

62 Internal Wet - Coupling and Adjustable (CAD: IWA-X-20-XX-XXX)

SENSOR SELECTION: PC-1000
MFG. DWG. IWA-1200
INSTALL. IWS-1800

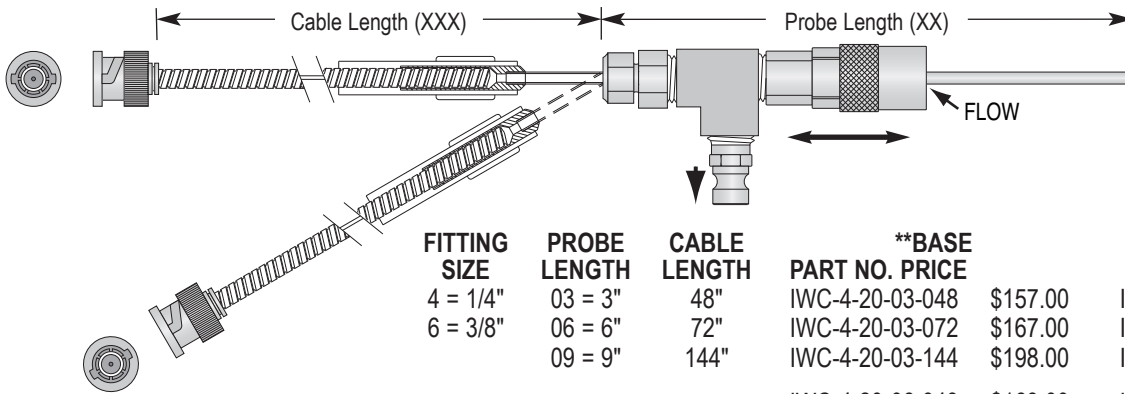

FITTING SIZE	PROBE LENGTH	CABLE LENGTH	PART NO.	**BASE PRICE	PART NO.	**BASE PRICE
4 = 1/4"	03 = 3"	48"	IWC-4-20-03-048	\$157.00	IWC-6-20-03-048	\$159.00
6 = 3/8"	06 = 6"	72"	IWC-4-20-03-072	\$167.00	IWC-6-20-03-072	\$169.00
	09 = 9"	144"	IWC-4-20-03-144	\$198.00	IWC-6-20-03-144	\$200.00
			IWC-4-20-06-048	\$163.00	IWC-6-20-06-048	\$165.00
			IWC-4-20-06-072	\$173.00	IWC-6-20-06-072	\$175.00
			IWC-4-20-06-144	\$204.00	IWC-6-20-06-144	\$206.00
			IWC-4-20-09-048	\$169.00	IWC-6-20-09-048	\$171.00
			IWC-4-20-09-072	\$179.00	IWC-6-20-09-072	\$181.00
			IWC-4-20-09-144	\$210.00	IWC-6-20-09-144	\$212.00

64 Internal Wet - Fixed (CAD: IWF-X-20-XX-XXX)

SENSOR SELECTION: PC-1000
MFG. DWG. IWD-1200
INSTALL. IWS-1800

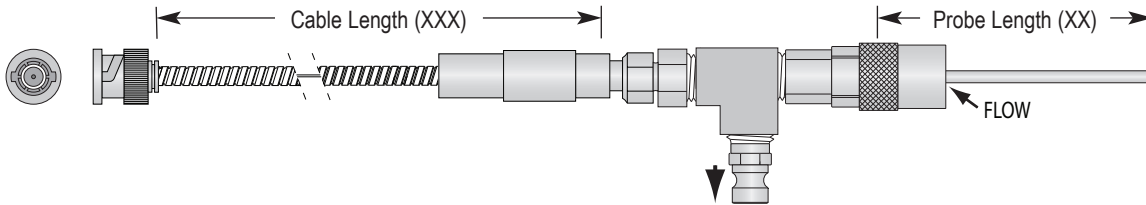

FITTING SIZE	PROBE LENGTH	CABLE LENGTH	PART NO.	**BASE PRICE	PART NO.	**BASE PRICE	PART NO.	**BASE PRICE
4 = 1/4"	03 = 3"	48"	IWF-4-20-03-048	\$157.00	IWF-6-20-03-048	\$159.00	IWF-8-20-03-048	\$163.00
6 = 3/8"	06 = 6"	72"	IWF-4-20-03-072	\$167.00	IWF-6-20-03-072	\$169.00	IWF-8-20-03-072	\$173.00
8 = 1/2"	09 = 9"	144"	IWF-4-20-03-144	\$198.00	IWF-6-20-03-144	\$200.00	IWF-8-20-03-144	\$204.00
			IWF-4-20-06-048	\$163.00	IWF-6-20-06-048	\$165.00	IWF-8-20-06-048	\$169.00
			IWF-4-20-06-072	\$173.00	IWF-6-20-06-072	\$175.00	IWF-8-20-06-072	\$179.00
			IWF-4-20-06-144	\$204.00	IWF-6-20-06-144	\$206.00	IWF-8-20-06-144	\$210.00
			IWF-4-20-09-048	\$169.00	IWF-6-20-09-048	\$171.00	IWF-8-20-09-048	\$175.00
			IWF-4-20-09-072	\$179.00	IWF-6-20-09-072	\$181.00	IWF-8-20-09-072	\$185.00
			IWF-4-20-09-144	\$210.00	IWF-6-20-09-144	\$212.00	IWF-8-20-09-144	\$216.00

Internal Wet Connector Sensors

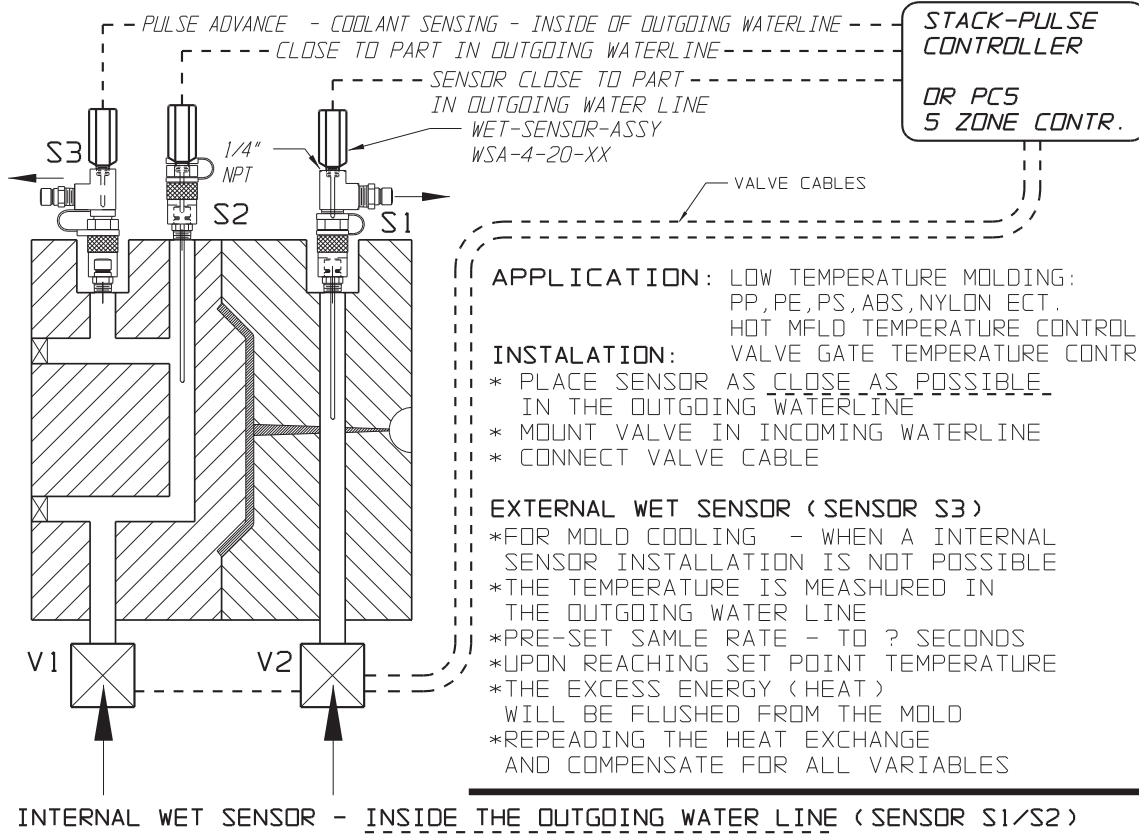

80 Internal Wet Sensor (CAD: IWS-X-20-XX)

MFG. DWG. IWS-1200
 INSTALL. IWS-1800
 IWS-1820
 IWS-1840

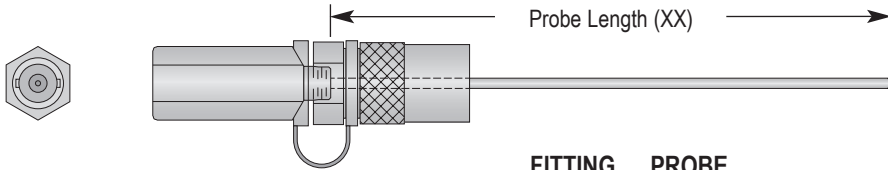

FITTING SIZE (X)	PROBE LENGTH	PART NO.	**BASE PRICE	PART NO.	**BASE PRICE
4 = 1/4"	01 = 1"	IWS-4-20-01 ...	\$122.00	IWS-6-20-01 ...	\$126.00
6 = 3/8"	02 = 2"	IWS-4-20-02 ...	\$123.00	IWS-6-20-02 ...	\$127.00
	03 = 3"	IWS-4-20-03 ...	\$124.00	IWS-6-20-03 ...	\$128.00
	04 = 4"	IWS-4-20-04 ...	\$125.00	IWS-6-20-04 ...	\$129.00
	06 = 6"	IWS-4-20-06 ...	\$127.00	IWS-6-20-06 ...	\$131.00
	08 = 8"	IWS-4-20-08 ...	\$129.00	IWS-6-20-08 ...	\$133.00
	12 = 12"	IWS-4-20-12 ...	\$146.00	IWS-6-20-12 ...	\$150.00

82 Internal Wet - Outgoing (CAD: IWO-X-20-XX)

MFG. DWG. IWO-1200
 INSTALL. IWO-1800
 IWO-1820
 IWO-1840

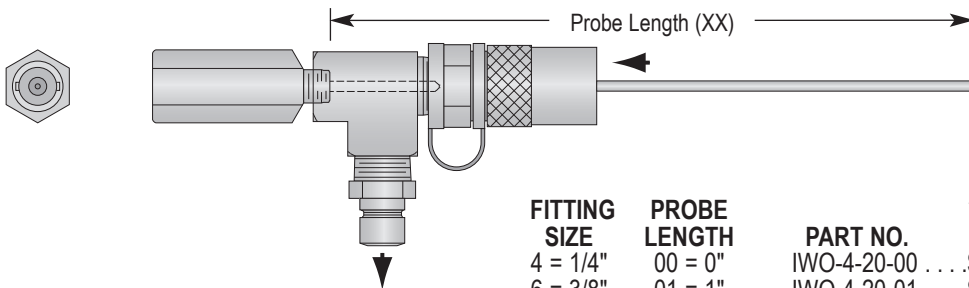

FITTING SIZE (X)	PROBE LENGTH	PART NO.	**BASE PRICE	PART NO.	**BASE PRICE
4 = 1/4"	00 = 0"	IWO-4-20-00 ...	\$146.00	IWO-6-20-00 ...	\$150.00
6 = 3/8"	01 = 1"	IWO-4-20-01 ...	\$147.00	IWO-6-20-01 ...	\$151.00
	02 = 2"	IWO-4-20-02 ...	\$148.00	IWO-6-20-02 ...	\$152.00
	03 = 3"	IWO-4-20-03 ...	\$149.00	IWO-6-20-03 ...	\$153.00
	04 = 4"	IWO-4-20-04 ...	\$151.00	IWO-6-20-04 ...	\$155.00
	08 = 8"	IWO-4-20-08 ...	\$153.00	IWO-6-20-08 ...	\$157.00
	12 = 12"	IWO-4-20-12 ...	\$170.00	IWO-6-20-12 ...	\$174.00

Sensor Guides

90 Sensor Guide Insert 3/16" Instructions - see MM-1710/1770 (used with Spring Bead Probes only)

MFG.DWG. SGI-1260

For CAD see: SG-Sensor-Guide.step

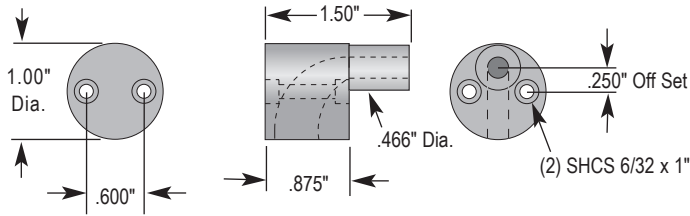

PART NO. SGI-6-875-1.5

PRICE \$ 34.00

91 Sensor Guide Tube 3/16" Installation instructions - see MM-1710/1770 (used with Spring Bead Probes only)

MFG.DWG. SGI-1260

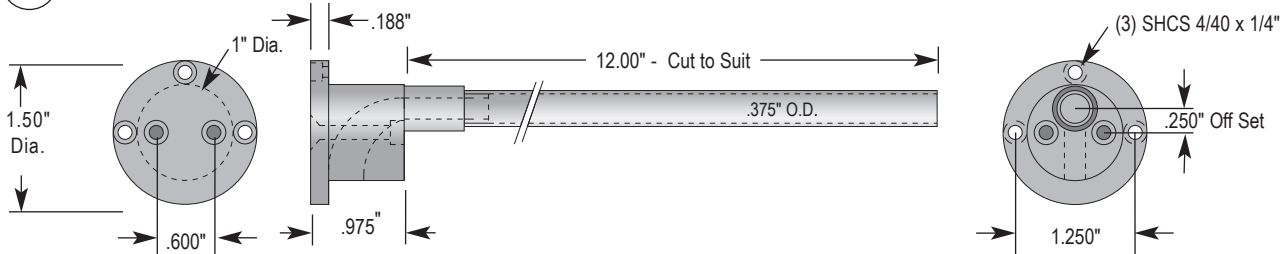

PART NO. SGT-6-875-12

PRICE \$ 47.00

92 Sensor Guide Insert 1/4" Installation instructions - see MM-1780 (used with Armored Spring Probe)

MFG.DWG. SGI-1280

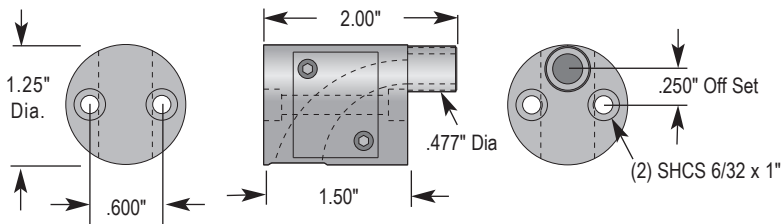

PART NO. SGI-8-1500-2

PRICE \$ 42.00

93 Sensor Guide Tube 1/4" Installation instructions - see MM-1780 (used with Armored Spring Probes only)

MFG.DWG. SGI-1282

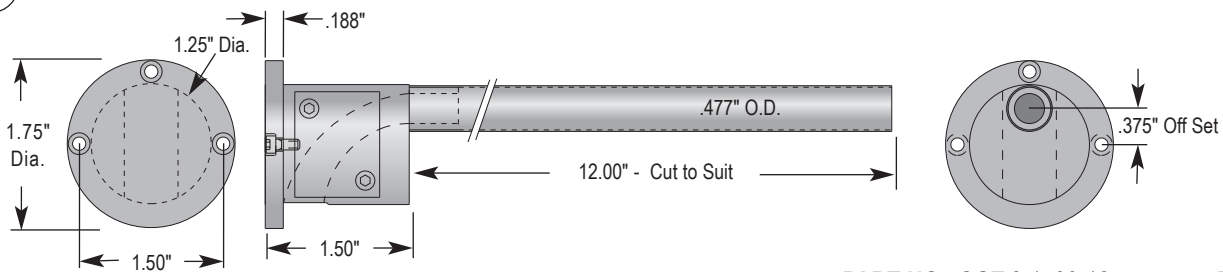

PART NO. SGT-8-1500-12

PRICE \$ 49.00

94 Sensor Guide (Flat) Tube 1/4" Installation instructions - see MM-1790 (used with Armored Spring Bead Probes)

MFG.DWG. SGI-1290

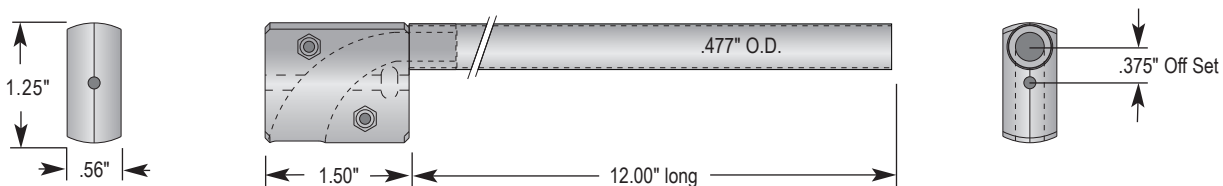

PART NO. SGF-8-1500-12

PRICE \$ 51.00

PC-PRICE-25-0114

Connection Cables

96 Sensor Junction Cable Use same Assembly for moveable and/or stationary.

MFG. DWG. SJC-1506

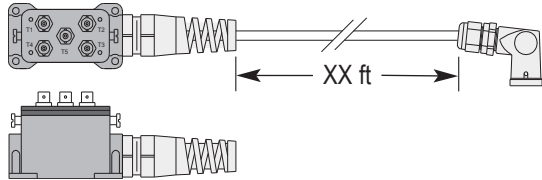

SJB-5-F-066 ft\$ 310.00
SJB-5-F-1212 ft\$ 336.00
SJB-5-F-2424 ft\$ 352.00

Sensor Junction Box - Mold Mounted Use same Assembly for moveable and/or stationary

MFG. DWG. SJB-1205

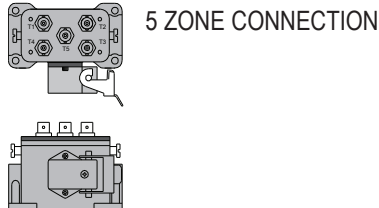

SJB-5\$ 288.00
-------	-------	----------------

Sensor Cable Ass'y Use same Assembly for moveable and/or stationary

MFG. DWG. SCA-1606

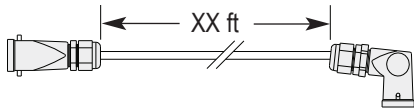

SCA-6-MF-066 ft\$ 104.00
SCA-6-MF-1212 ft\$ 120.00
SCA-6-MF-2424 ft\$ 136.00

Direct Connection - Sensor to Valve

